



OceanView[®]

Impact-Resistant Windows & Doors · *Impress the Weather*



Strength



Reliability



Performance



Innovation





Style

Elegance



Splendor





Table of Contents

The Science of Windows	1
Manufacturing OceanView	3
Glass Lamination	5
Glass Tempering	6
Impact Testing	7
Thermal Performance	9
Fortified Housing	11
Single- and Double-Hung	13
Specialized Performance: Features and Benefits	15
Combination Units	17
Geometric Shapes	19
Picture Windows	21
Casement and Awning Windows	23
Sliding Windows	25
Patio Doors	27
Options	29
Grid Options	31
Trim Casing Options	32
Accessories	33

Window Sizes and Detail Drawings

Single-Hung	35
Double-Hung	38
Geometric Windows	41
Sliding Windows	43
Picture and Transom Windows	44
Casement and Awning Windows	45
Patio Doors	49
Patio Doors Sidelite & Transom	52
Patio Doors Geometric Shapes	53
Casing & Brickmold	54

The. *science* of windows.

Over twenty years ago, during a decade of extreme weather conditions such as Hurricane Andrew and other natural disasters, Viwinco invested significant time and resources in expanding our study of the science of windows. We had our eyes on a goal: to create products of the future. Products that would stand up to brutal weather conditions and prevent the destruction caused to homes along the coast by gusting, turbulent winds and wind-borne debris.

To achieve this, we added in-house laminating and tempered glass lines to our manufacturing facility, to closely monitor quality. We also obtained our own specialized air cannon, and within our test facility fired projectiles at windows to learn how to create more resilient products. This past year we began the construction of a state-of-the-art glass processing facility to continue improving upon our already impressive products.

With all this knowledge, we designed and introduced the next generation of windows: our certified impact-resistant OceanView line. Impact-resistant. Thermally efficient. Ready.

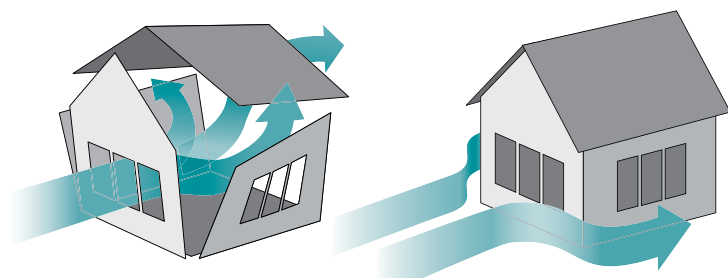

OceanView windows are certified impact-resistant—preventing wind and debris from entering the house, lifting up the roof and pushing the walls outward.









Conceived of,
Designed,
Manufactured
and Tested...

In House.

Viwinco's production methods make us one of the most trusted and reliable manufacturers of impact products in the country. Since we control the source, we also control the quality of every single window that leaves our manufacturing facility. Viwinco operates dedicated tempering and laminating departments, both of which utilize the most technologically advanced equipment and function under the leadership of an expert staff.

Laminated glass consists of a piece of .090 polyvinyl butyral (PVB)—a resilient, flexible interlayer—pressed between a double-pane of clear glass and a pane of tempered low-e glass.



Left: Assembling laminated glass in a clean room, which is dust-free and controlled for temperature and humidity. This protects the glass from impurities, helping to ensure that nothing interferes with the lamination process.

Above: The two layers of glass, with PVB laminate sandwiched in between, adhere to each other after having been heated in an infrared oven.

Laminated Glass



After the glass exits the infrared oven, it is stacked on racks. In the final step of the lamination process, the racks are heated in the autoclave at 270°F, 170 psi for 3.5 hours.

Glass Lamination.

The PVB interlayer is the key ingredient in laminated glass. It's designed to keep the window intact when hit by objects that become windborne—and possibly as damaging as a missile—during a hurricane. Laminated glass also withstands tremendous pressure under windloads.

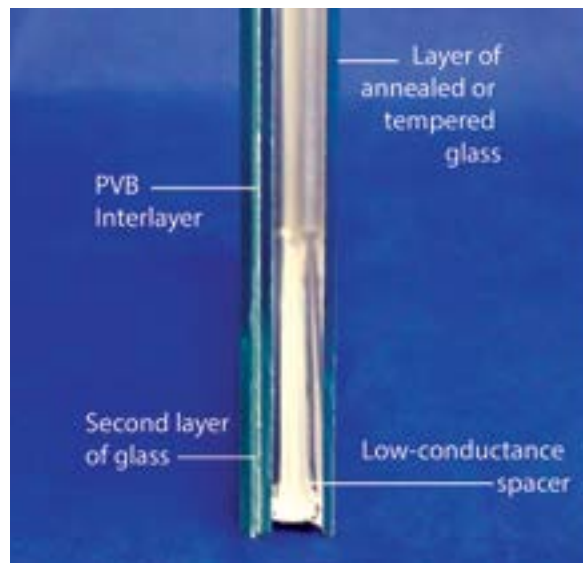



Rollers feed the glass into the tempering oven. Also referred to as "safety glass," tempered glass, shatters into small cubes when broken, as opposed to jagged shards.

Glass Tempering.

The process requires glass to be heated to approximately 1200°F and then immediately force-cooled with air nozzles to create surface and edge compression. From the compression comes strength: tempered glass is four to five times as strong as regular annealed glass. A surface compression of 10,000 psi or more and an edge compression of 9,700 psi or more ensures that, if the glass does break, it will fracture into tiny cubes referred to as "dice."

1. First, we laser-etch the Viwinco certification logo onto each piece of glass.
2. Next, the glass proceeds through our seaming line, where the edges are polished.
3. Once it is washed, the glass is sent through to the tempering oven. The length of time the glass is heated depends on its thickness.
4. After the glass is cooled, it is placed on a cart and sent to the insulated glass department.

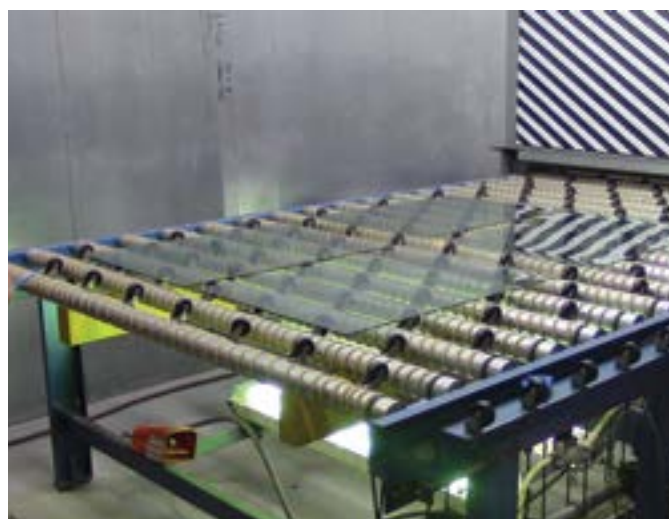

Quality Control. A Combination of Checks: Tempered glass is both visually inspected and measured with a series of gauges to ensure it meets industry standards for optical clarity.

The Gold Standard

Our on-site state-of-the-art Research and Development Center is home to our own certified test wall. The wall's unique wall-and-control panel design is the industry's "Gold Standard" for accuracy in testing. Here, we subject our prototypes to severe simulated weather and atmospheric events to examine performance and suitability.

Testing is performed first by our own team of engineers. The advantage of doing this is simple: we observe potential problems firsthand, and engineer solutions as a team. We take time to precisely analyze how the parts work with the whole. Then, we invite third-party technicians from Architectural Testing to visit our site and carry out required independent testing. Outside testing requirements are demanding. Our own targeted performance levels are even more stringent.

The windows are evaluated and accorded a performance-based grade in four key areas. Ever-increasing test levels must be met in the following categories: Structural, Air Infiltration, Water Infiltration, and Forced Entry. Only windows that achieve a baseline rating of Design Pressure (DP) 50* may move on to the impact and cycling testing described below, which they must pass in order to achieve the stringent industry standards set by the American Society for Testing and Materials (ASTM) for coastal applications.

Vivinco subjects its windows to Missile Level D impact testing. In the initial part of the test, four windows are shot, in designated areas, with a 9-pound, 8-foot-long 2x4 that is projected out of a cannon. The 2x4 travels at 50 feet per second—the equivalent of 34 mph. To pass this part of the test, the outside tempered piece may break (into its characteristic small, smooth-edged pieces), but the inside laminated glass must remain entirely intact.

After the windows are shot, they are bagged off and subjected to 4500 positive and 4500 negative wind cycles at speeds up to 139.8 mph and gusts up to 172 mph for at least two and a half hours. The positive pressure simulates wind from a hurricane approaching the house; negative pressure simulates wind at the back side of the house. In order to pass, the glazing system must withstand the constant push and pull of the wind.

OceanView windows perform spectacularly when subjected to wind pressures and windborne debris. We've tested and passed impact products to the industry standard of Impact DP50, and well beyond it, too. Depending on the style, you'll find ratings up to Impact DP75. In a hurricane, this helps ensure the integrity of the entire building envelope.

*DP, or Design Pressure, is a rating that indicates a window's resistance to wind load and water penetration





Missile Level D resistant.
OceanView windows
withstand a 2x4 traveling
at 50 feet per second.



Increased Security...

an added benefit:

The double pane of laminated glass and single pane of tempered glass create a powerful barrier, minimizing the risk of forced entry.

Superior Insulating Value.

OceanView windows do more than withstand hurricane conditions. They also resist the impact of the sun—providing maximum energy efficiency.

- Tempered, Low-E glass
- 15/16" Double-strength, laminated glass
- Argon fill
- Low-conductance spacer

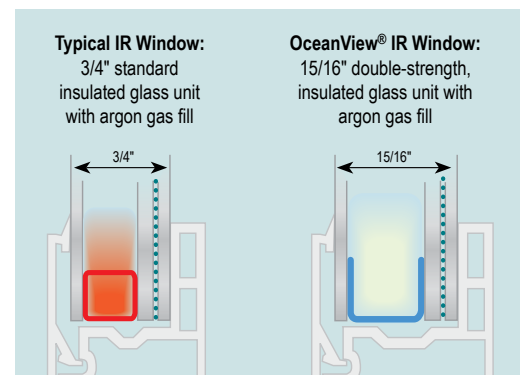

As a result...

In warmer months and climates, your home stays cooler on the inside, decreasing the amount of air conditioning needed.

Everyone and everything inside the home is protected from damaging UV rays: the Low-E and laminated glass panel cut down on almost all UV light while allowing visible light full entry.

Noise from the outside is greatly reduced. The combination of laminated glass, low-conductance spacer, and argon gas contribute to a significant reduction in sound transmission.

Colored Glass

Glazing options include gray tint or obscure glass.

Gray tinted glass reduces solar heat gain; obscure glass increases privacy. Since our gray glass provides a visible light transmittance of $\leq 45\%$, it meets Turtle Glass requirements.



Gray-tinted



Obscure glass



Viwinco *Fortified*

In 2011, the Institute for Business and Home Safety (IBHS) awarded a home in Surf City, North Carolina the FORTIFIED for Existing Homes™ Hurricane Resistance Gold Designation. It was the first home in the state to achieve the award.

Viwinco is proud to have supplied the windows for this project. FORTIFIED Home is a program designed to help homeowners build safer, stronger new homes, and retrofit existing ones to reduce residential property losses in hurricane-prone areas. The Gold level represents the highest level of achievement and the greatest disaster protection.



Ever since the fortified home that the builder constructed in 2011 won Hurricane Resistance Gold Designation, he has been dedicated to Fortified housing. In 2014, he installed OceanView windows in his own home (pictured above and to the left) in Hampstead, North Carolina.

Added *Strength.* Exactly where you need it most.

All our OceanView single- and double-hung windows include our patented reinforcement system with Tilt-*n*-Lock technology. This fortifies the window in the most essential spot: along the meeting rail. Tilt-latch slide bolts are housed within the reinforcement to strengthen the meeting rail from jamb to jamb. The window also boasts an integrated sill interlock, which ties the upper sill to the lower sash when closed. During severe wind conditions, the sill interlock helps prevent negative pressure on the leeward face of the house from acting on the windows and creating the suction that could potentially pull the windows out of the back of the house and severely damage the building envelope.

On **SINGLE-HUNG WINDOWS**, the bottom sash is operable and the top sash is fixed. Just raise the bottom sash for the ventilation you desire. Single-hungs are economical, easily serviceable, and allow for easy access to dry wall materials during construction. Since our single-hung looks exactly like our double-hung, you can install both types of windows in different areas of your home and still achieve a consistent look. They also offer exceptional energy efficiency.

On **DOUBLE-HUNG WINDOWS**, both sashes are operable: the bottom sash lifts up and the top pulls down. Double-hungs offer beautiful sight lines and maximum ventilation.

For window sizes and detail drawings, see pages 35-40.





Tilt-*n*-Lock

HARDWARE

Standard on OceanView
single- and double-hung windows

Exclusive Technology:

- One-handed operation
- Clean sight lines
- Easier cleaning



Locked Position
Sash is securely locked.
Hidden tilt latches are
housed in sash channel
for added strength.



Unlocked Position
At the 150-degree
position, the hidden
tilt latches are engaged
with the jamb, and the
sash can be lifted.



Tilt-In Position
When the lever is moved
to 180-degrees, the hidden
tilt latches clear the jamb
channel, allowing the
user to easily tilt the
sash inward.

specialized *Performance*

OceanView Windows are available for new construction and replacement applications.

Standard features:

1. 1-1/4" Integral, pre-punched nailing fin contributes to trouble-free installation. Available with nailing fin for new construction projects and without fin for replacement projects
2. Beveled exterior for traditional craftsmanship look
3. Viwinco's vinyl profiles are manufactured with over five pounds more PVC than the competition for increased structural integrity. The chambers add thermal efficiency and strength
4. Equally sized glass in both sashes for balanced design
5. Single- and double-hung windows come with our patented reinforcement system with Tilt-n-Lock hardware, which provides strength where it's most needed, along the interlock. The reinforcement becomes the housing for the hardware that allows you to use the lock to tilt the sash in with just one hand. Tilt latches are not visible
6. Sash interlock for added security and thermal efficiency
7. Standard high-performance glass package features 15/16" double-strength, laminated glass (.090" interlayer thickness); tempered, Low-E; thermal spacer, and argon gas fill
8. 5-Degree true sloped sill with mortised-in, replaceable 1-3/8" high weatherstripped sill dam
9. Screen track secures screen to better block insects
10. Snap-in accessory expands J-channel to 1-1/4" to receive greater range of cladding thicknesses
11. Fully fusion-welded vinyl frame and sash for strength, durability and low-maintenance
12. Dual nite-vents limit sash travel for ventilation and added security
13. Locking pivot bar secures sash to frame and stabilizes window for shipping
14. Stainless-steel, 3/4" constant-force balance eliminates sash drift and never needs adjustment
15. Integral designer lift rails make sash operation easy and comfortable
16. Fully welded sill dam with a mortised-in, replaceable weather stripped leg increases strength and performance. **OceanView Plus upgrade provides a higher sill dam, in turn meeting DP70**
17. Sill interlock secures sash in place for better performance under negative pressure loads
18. Integral J-channel saves time on exterior finishing

Heavy-duty extruded screen frames are standard



OceanView single-hung matches the appearance of our double-hung, but only the lower sash is operable

For window sizes and detail drawings, see pages 35-52.







Freedom of *style*

With every design choice you make, your home reflects your personality. Your windows are part of that equation. A way *into* the outdoors, they also shape how you experience the world. Your view, whether it's of the ocean or your front yard, is personal.

Since OceanView windows come custom-made in all our styles*, your window choice will contribute to the unique sense of place that will be etched into your family's mind forever. From the classic atmosphere generated by hung windows to the singularity of geometrics and the original perspective they both capture and provide, you'll find the windows that speak to you in these pages.

Structural Mullions

Our powerful mullion system makes it possible to combine select windows of the same or different shapes in a pattern all your own. Tested and rated by the American Architectural Manufacturers Association, OceanView's structural mullion attaches directly to the rough opening, delivering great strength and stability to the finished installation—even at large sizes. We also offer the option to create expansive window walls with our casements, casement fixed windows, and awnings. See pages 23-24 for more details.

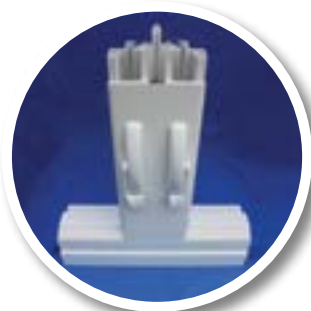

Integral Mullion
(continuous head and sill)
for mulling casement, casement picture, and awning windows.



Structural Mullion
used to mull two or more units together.
Interior view.

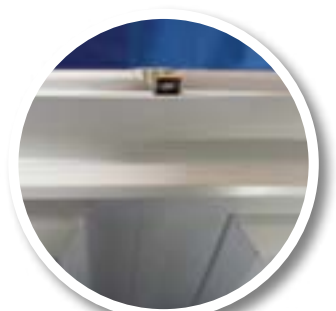

Drip Cap with Bracket
to attach mullion to rough opening.

Structural mullions provide increased integrity between horizontally and/or vertically adjacent mounted windows. A window-wall mullion is available for casements and awnings.

*See pages 19-28 for our full range of styles. Bay and bow windows, though not pictured in the catalog, are also available in sizes up to 120" x 72".





Geometric Shapes

We design windows of almost any geometric shape, and offer many different grid patterns to choose from. Use our geos alone, or pair them with a different fixed or operable window to achieve a truly spectacular, custom look in any room.

Geometric Windows are available with all of our color and other options. See pages 29-32 for details.

Style Options

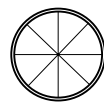

Circle

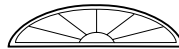

Elliptical



Half-Round



Extended-Arch

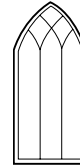

Gothic

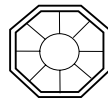

Octagon

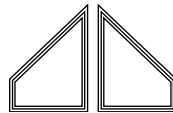

Trapezoids

For additional shapes and grid options, see pages 41-42. Custom-made shapes and custom grids are also available.

Note: When geometric and picture windows are mullered together, sightlines will not be even.

Geometric Features

1. Integral J-channel saves time on exterior finishing
2. Snap-in accessory expands J-channel to 1-1/4" to receive a greater range of cladding thicknesses
3. 15/16" Double-strength laminated glass, tempered, Low-E glass, thermal Super Spacer[®], and argon gas fill
4. Chambered vinyl profiles add thermal efficiency and structural strength
5. Fully fusion-welded sash and frame for strength, durability and low-maintenance
6. 1-1/4" Integral, pre-punched nailing fin contributes to a trouble-free installation



Picture Windows

Picture windows let the light, and the view, pour in. Add a transom above for a particularly distinctive look, or enrich the atmosphere in any room by flanking with the same or different styles.

Our most practical windows, pictures provide the highest energy-efficiency solution to homeowners.

Picture windows are available with all of our color and other options. See pages 29-32 for details.

Selected Combinations

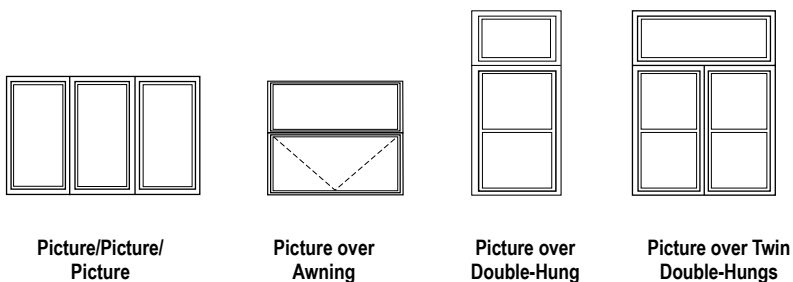

Picture Features

1. 15/16" Double-strength laminated glass, tempered, Low-E glass, thermal spacer, and argon gas fill
2. Extruded glazing bead is mitered in the corners for a hand-crafted look
3. Fully fusion-welded frame for strength, durability and low-maintenance
4. 1-1/4" Integral, pre-punched nailing fin contributes to a trouble-free installation



For window sizes and detail drawings, see page 44.







Casement Windows

Our casement windows provide beautiful views and smooth operation. Use as the only window style in your home—or to complement other styles. Hinged at the left or the right depending on your needs, they swing open to the outside with a simple turn of the handle. Multiple casements or awnings may be combined to create a window wall. Our structurally reinforced window-wall mull maximizes visible glass between sashes for a wider viewing area and abundant light.



We also offer a **Colonial Casement** (left).

It's designed to look like a double-hung window, but provides the egress features of a casement window. Fixed casements (also referred to as casement picture windows) are available, too.

All our casement windows are available with our color and other options. See pages 29-32 for details.

Possible Combinations

Handing is viewed from the outside



Pictured above new modern lock and handle paired with stainless-steel operator, hinge track, and hinge arm

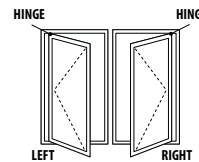

Twin Casement

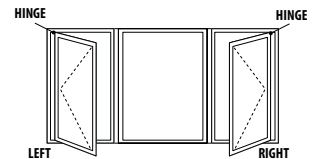

Casement/Picture/Casement

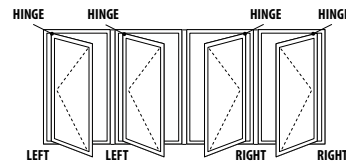

Combination Quad Casement

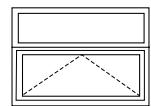

Awning w/Transom
Hinged at Top

Casement Features

Casements include all the features of our other complementary styles as well as...

1. 15/16" Double-strength laminated glass, tempered Low-E glass, thermal spacer, and argon gas fill
2. Multipoint lock for added security and snug sash closure
3. Operating hinges that open 90° to allow for easy cleaning. Optional egress hardware available, stainless-steel hardware is standard on all casement and awning windows
4. Standard with stainless steel hardware for added strength and durability as well as our new modern handle and lock for a sleek finished look. A folding handle means less interference with window treatments and easy removal of screens
5. Hardware attachment points that are reinforced for a lifetime of reliable operation
6. Integral glazing bead for a weather-tight seal

Triple weatherstripping for a tight seal against wind, water, sound, and airborne particles—as well as top thermal performance

Aluminum reinforcement in the sash and frame provides structural integrity

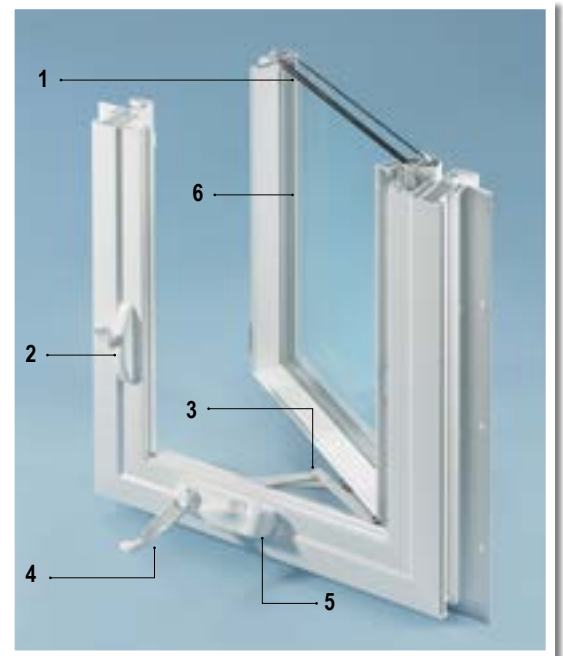

For window sizes and detail drawings, see pages 45-48.



Sliding Windows

Sliding windows, also referred to as Sliders or gliding windows, are designed with space in mind: they won't obstruct passage or protrude into or outside of your living area. They're particularly convenient for window spaces that are wider than they are tall and where access may be difficult. Since they open horizontally, they don't require the lifting force of single-or double-hung windows. Easy to operate, sliders also offer trouble-free maintenance: just lift out the sash, spray, and wipe.

- Positive latching with adjustable keeper and cam-style lock
- Interlock on sashes for energy conservation and durability

OceanView's 2-Lite Slider features two sashes that open. It offers a more contemporary look than a traditional hung window, and can be combined with other sliders to extend across the wall for an open and airy feel.

Style Options

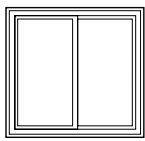

2-Lite Slider
(1/2-1/2)

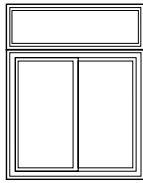

**Transom over
2-Lite Slider**
(1/2-1/2)

Sliding Windows are available with all of our color and other options. See pages 29-32 for details.

Slider Features

1. Cam-style lock with adjustable keeper for reliable alignment and positive locking
2. Sashes interlock for thermal performance, alignment, and strength
3. 15/16" Double-strength, laminated glass, tempered, Low-E glass, thermal spacer and argon gas fill
4. Sash track with monorail-design slider pad provides smooth glide operation
5. Both sashes operate for ventilation. Both sashes lift out for safe cleaning from the inside
6. Extruded designer pull rails (on both sashes) make sash operation easy and comfortable
7. Fully fusion-welded frame and sash for structural strength and durability

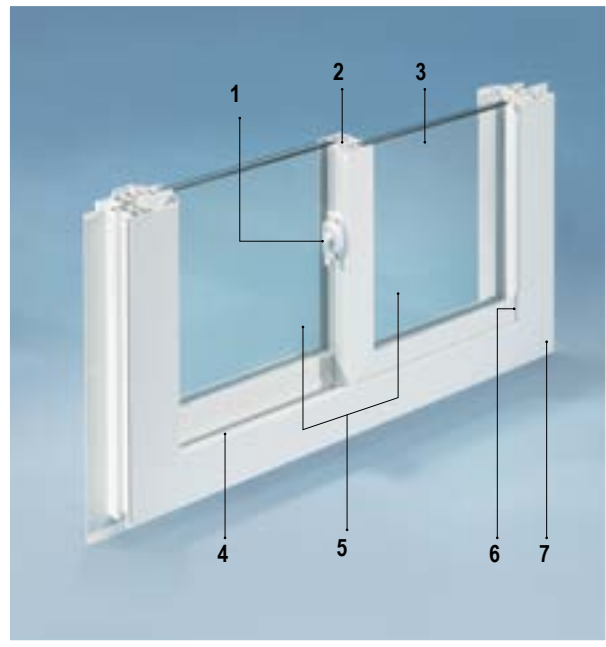

For window sizes and detail drawings, see page 43.

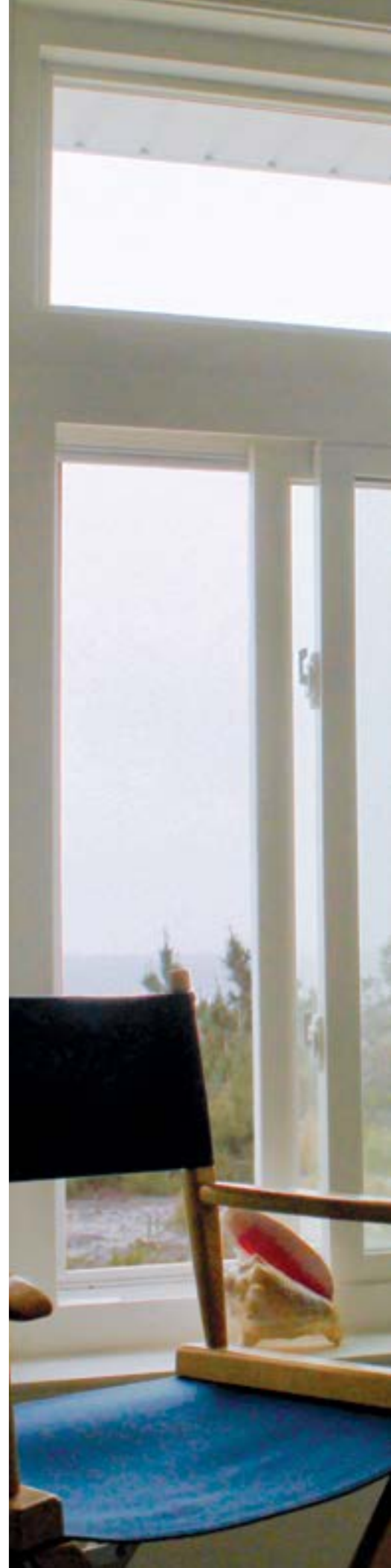



One Door. *Many talents.*

OceanView patio doors are powerfully constructed from a fully fusion-welded frame and panel. Advanced engineering creates exceptional glide dependability and easy operation, with under eight pounds of operating force.

Patio Door Customization

- 2-, 3-, and 4-panel doors are available with a vinyl sill.
- Grid patterns include colonial and prairie, in flat or deluxe styles. SDLs also available.
- Knock down assembly option available for 2-lite, 3-lite, and 4-lite patio doors. See page 49 for details.
- Patio Doors are available with all of our color and other options. See pages 29-32 for details.

Our gray glass provides a visible light transmittance of $\leq 45\%$, and meets Turtle Glass requirements.

Gray-tinted



Patio Door Features

1. Snap-in J-channel accessory is available to allow for a 3/4" or a 1-1/4" J-channel pocket for siding with a brick mold look on the exterior
2. 1" Overall thickness, double-strength laminated glass, double-strength Low-E tempered glass, thermal spacer, and argon gas fill for strength and thermal efficiency
3. Head and jamb track covers for a finished appearance
4. Extruded glazing bead is mitered in the corners for a hand-crafted look
5. Precision-cut and fusion-welded frame creates a powerfully-built sliding patio door. 4" stiles and a slim frame maximize the viewing area
6. Weep hole system is located beneath the screen track
7. Independent screen track keeps screen in place during travel
8. Threshold cover keeps out dirt, grass and leaves

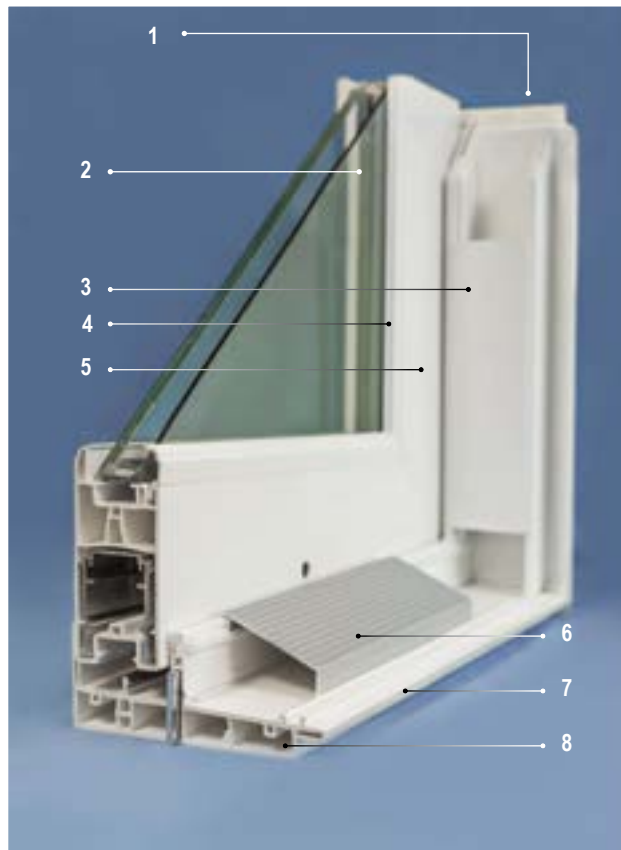

Style Options

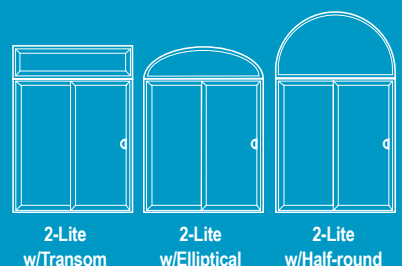
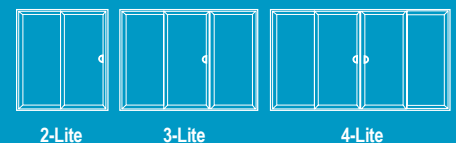

For window sizes and detail drawings, see pages 49-51.



NEW Door Handle Options



Our new patio door handles will be used to replace our existing "D-Handle". These patio door handles feature a more-modern look, a two-point locking system and are comprised of heavy-duty components to assure positive locking. The robust squared handle enhances the overall finish of the door with its sleek lines and ergonomic design. These handles contain the same punch settings as the D-Handle and can easily replace the existing handle if needed. The new locks may be either keyed or non-keyed.

Patio Door Handing Options

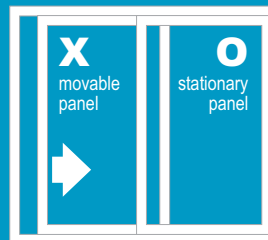

Left-Hand Operation
Viewed from outside

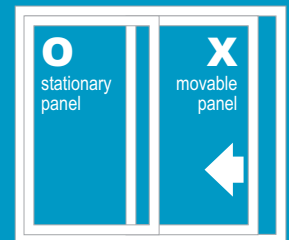

Right-Hand Operation
Viewed from outside



3800



Options

That Are Ideal For Coastal Regions

Windows and doors are one of the most eye-catching aspects of a home and adding color is one of the easiest ways to add personality. Viwinco's exterior laminates do more than just bring personality to your home however, they are the most robust and enduring you can find. Engineered to outperform some of the harshest conditions, our exterior laminates are proven to withstand the test of time while maintaining the bold colors you want. Did we mention our laminates also provide exceptional thermal performance? Our premium laminates are comprised of multiple thin layers that result in a finish that is highly resistant to harmful ultraviolet light and salty air (ideal for coastal applications). Durable, efficient, and bold, our exterior colored laminates are the perfect solution to adding personalization to any project.

Traditional Solid Extrusions:

OceanView windows are offered in traditional interior/exterior solid extrusions, or with any of our color options.



White

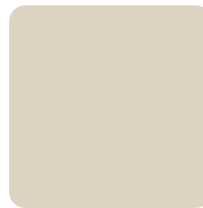

Tan



Clay

VIWINCO COLORS Available with white interior only



Bronze

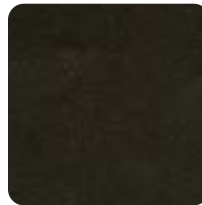

Midnight Black

- Triple-layer construction for exceptional durability
- More robust than paint: won't chip, crack, or fade
- Heat-reflective technology
- Impervious to the damaging effects of moisture and salt; ideal for coastal regions



Top: Double-hungs with simulated divided lites, exterior view. Below, right: Close-up exterior view of simulated divided lites

Grids

Grids add definition to your window, dimension to a room, and character to your home. Sealed between the glass for easy cleaning, they are available in two styles—flat internal and deluxe internal.



Simulated divided lites with Midnight Black exterior laminate

Windows with exterior laminate are available with color-matched deluxe grids or simulated divided lites.

Patterns:

Colonial, Prairie, Double Prairie, Diamond (flat internal only), Queen Anne, Valance, or specialty designs.

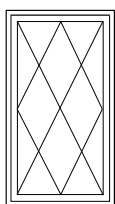

Diamond

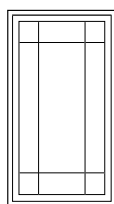

Prairie

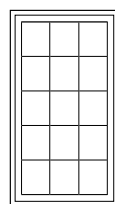

Colonial



Deluxe (top), Standard (bottom)

Simulated Divided Lites

Achieve the classic look of authentic divided lites while enhancing your window's energy efficiency.

- Great for historic restorations
- Permanently adhere to the inside and outside of the window. Our deluxe grids are placed between the glass, acting as a spacer.
- Offered in all of our solid extrusions, and exterior colors





3-1/2" Flat casing picture frame with bullnose sill



Exterior Trim and Brick Molding

Only available on new construction windows.

Accentuate your style and significantly reduce window installation and finishing time with our maintenance-free, highly durable PVC trim options.

Available in any of our exterior colors, our 3-1/2" flat casing and 2-1/4" brick molding are fully welded, factory applied, and come with an extruded J-channel pocket.

For installations where a J-channel pocket is not required, pocket filler is available. Both exterior trim options are offered with either a picture-frame or bullnose sill.

For detail drawings, see page 54.



Left: 2-1/4" Brick mold with bullnose sill

Inset: 3-1/2" Flat casing picture frame with bullnose sill



Accessories

Designed to make installation a breeze.

Viwinco engineers its windows and patio doors to be easier for the homeowner or contractor to install. To further aid in the installation process, we offer additional accessory options.

- 1-1/4" Snap-in J-channel
- Mulled Units
- Jamb Extensions

Snap-in J-channel

- Available sizes, patio doors: 3/4" or 1-1/4" snap-in J-channel for patio door expands the pocket to accept a variety of exterior cladding
- Available size, windows: 1-1/4"
- J-channel pocket filler available for windows for use with fiber cement or masonry applications
- Only available on new construction windows

Snap-in J-channel

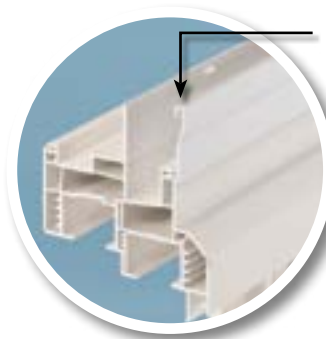

1-1/4"

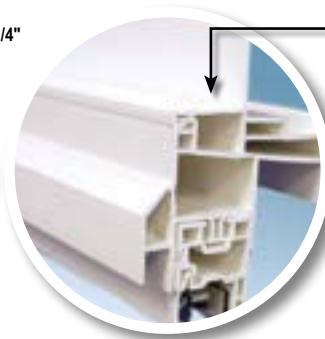

J-channel pocket filler

Extension Jamb

- Factory applied
- Available sizes: 4-5/8" and 6-5/8". We can also accommodate requests for jamb to be made any size smaller than 6-5/8"
- Only available on new construction windows

Jamb Extensions











































































Florida Flange

Florida Flange, also referred to as a flush fin window, is used primarily in concrete applications with block openings. It is attached to the wood framework or buck that is sealed to the masonry wall.

Florida Flange



Rough Opening	Single-Hung									
	20"	24"	28"	32"	36"	40"	44"	48"	52"	
Unit Size	19 1/2"	23 1/2"	27 1/2"	31 1/2"	35 1/2"	39 1/2"	43 1/2"	47 1/2"	51 1/2"	
Sash Opening	13 7/16"	17 7/16"	21 7/16"	25 7/16"	29 7/16"	33 7/16"	37 7/16"	41 7/16"	47 5/16"	
Visible Glass-Sash	11 13/16"	15 13/16"	19 13/16"	23 13/16"	27 13/16"	31 13/16"	35 13/16"	39 13/16"	44 3/4"	
36"	 OVSH2036	 OVSH2436	 OVSH2836	 OVSH3236	 OVSH3636	 OVSH4036	 OVSH4436	 OVSH4836	 OVSH5236	
44"	 OVSH2044	 OVSH2444	 OVSH2844	 OVSH3244	 OVSH3644	 OVSH4044	 OVSH4444	 OVSH4844	 OVSH5244	
48"	 OVSH2048	 OVSH2448	 OVSH2848	 OVSH3248	 OVSH3648	 OVSH4048	 OVSH4448	 OVSH4848	 OVSH5248	
52"	 OVSH2052	 OVSH2452	 OVSH2852	 OVSH3252	 OVSH3652	 OVSH4052	 OVSH4452	 OVSH4852	 OVSH5252	
60"	 OVSH2060	 OVSH2460	 OVSH2860	 OVSH3260	 OVSH3660	 OVSH4060 ❶	 OVSH4460 ❶	 OVSH4860 ❶	 OVSH5260 ❶	
66"	 OVSH2066	 OVSH2466	 OVSH2866	 OVSH3266	 OVSH3666 ❶	 OVSH4066 ❶	 OVSH4466 ❶	 OVSH4866 ❶	 OVSH5266 ❶	
72"	 OVSH2072	 OVSH2472	 OVSH2872	 OVSH3272	 OVSH3672 ❶	 OVSH4072 ❶	 OVSH4472 ❶	 OVSH4872 ❶	 OVSH5272 ❶	
80"	 OVSH2080	 OVSH2480	 OVSH2880	 OVSH3280	 OVSH3680 ❶	 OVSH4080 ❶	 OVSH4480 ❶	 OVSH4880 ❶	 OVSH5280 ❶	

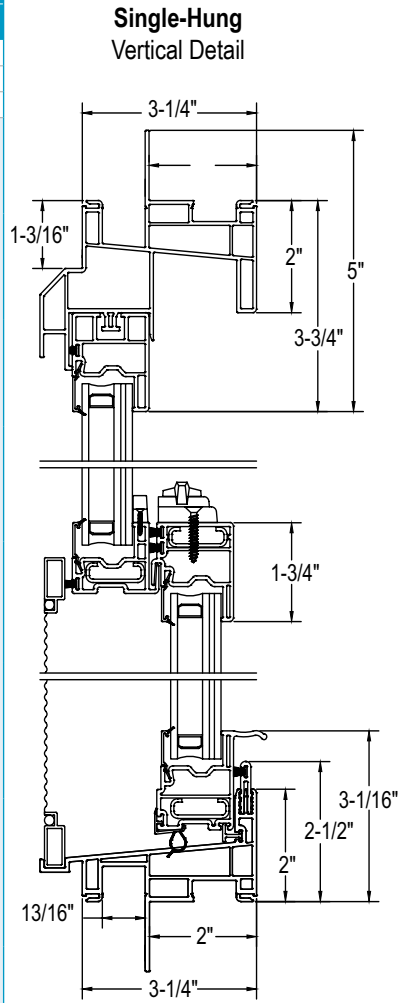

Callout sizes are expressed in inches and equal rough opening.

Single-hung windows have an interior frame depth of 2" and an exterior projection of 1-3/16" from the nail fin.

When mulling a unit to a single-hung, overall rough opening is not affected by the mullion.

Picture or transom windows have an interior frame depth of 2" and an exterior projection of 2" from the nail fin.

66" tall windows are the maximum size available as oriels. Oriels are windows having 60% to 40% sash height proportions with the larger sash on top. Reverse oriels have the smaller sash on top.

- ❶ Meets egress of:
Clear openable area ≥ 5.7 sq. ft.
Clear openable width ≥ 20"
Clear openable height ≥ 24"
- ❷ 2U1R2C: Mullied two-unit (one row, two columns).
- ❸ 3U1R3C: Mullied three-unit (one row, three column).

❹ All sizes shown meet DP50 rating.

For the latest testing data, contact Customer Service or visit our website at www.Viwinco.com.





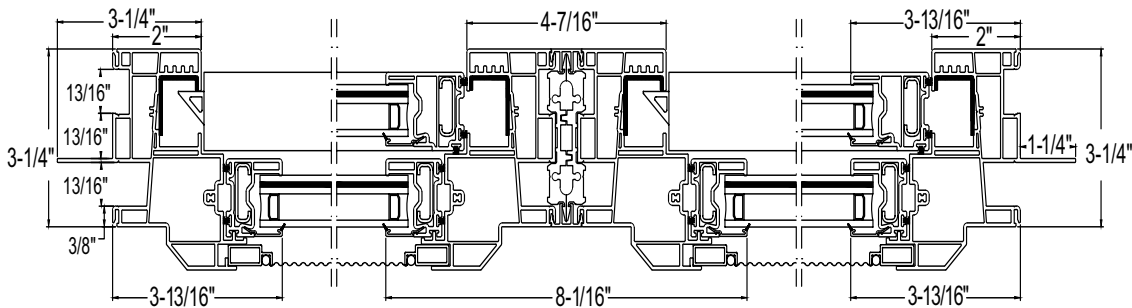



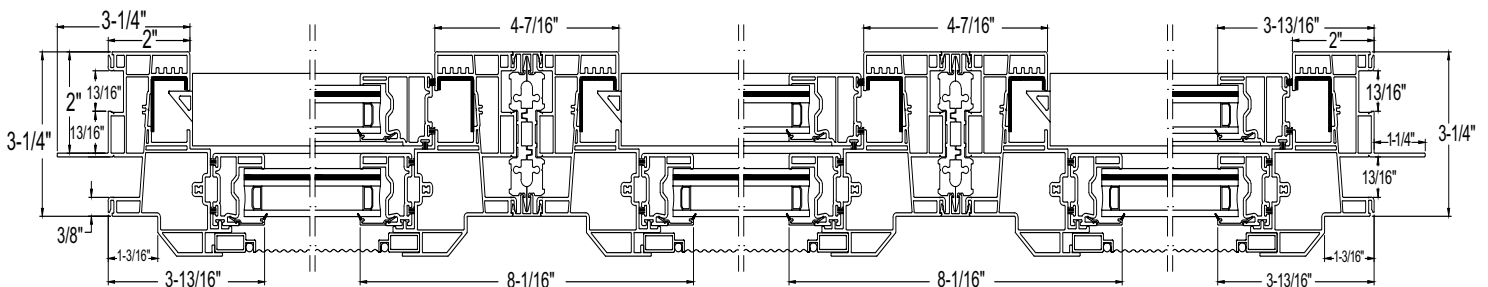



Rough Opening	Twin Single-Hung 2U1R2C [®]			Triple Single-Hung 3U1R3C [®]	
	56"	64"	72"	84"	96"
Unit Size	55 1/2"	63 1/2"	71 1/2"	83 1/2"	95 1/2"
Sash Opening	21 7/16"	25 7/16"	29 7/16"	21 3/16"	25 7/16"
Visible Glass-Sash	19 13/16"	23 13/16"	27 13/16"	19 13/16"	23 13/16"
36"	35 1/2" 13 9/16"	35 1/2" 13 9/16"	35 1/2" 13 9/16"	35 1/2" 13 9/16"	35 1/2" 13 9/16"
44"	43 1/2" 17 9/16"	43 1/2" 17 9/16"	43 1/2" 17 9/16"	43 1/2" 17 9/16"	43 1/2" 17 9/16"
48"	47 1/2" 19 9/16"	47 1/2" 19 9/16"	47 1/2" 19 9/16"	47 1/2" 19 9/16"	47 1/2" 19 9/16"
52"	51 1/2" 21 9/16"	51 1/2" 21 9/16"	51 1/2" 21 9/16"	51 1/2" 21 9/16"	51 1/2" 21 9/16"
60"	59 1/2" 25 9/16"	59 1/2" 25 9/16"	59 1/2" 25 9/16"	59 1/2" 25 9/16"	59 1/2" 25 9/16"
66"	65 1/2" 28 9/16"	65 1/2" 28 9/16"	65 1/2" 28 9/16"	65 1/2" 28 9/16"	65 1/2" 28 9/16"
72"	71 1/2" 31 9/16"	71 1/2" 31 9/16"	71 1/2" 31 9/16"	71 1/2" 31 9/16"	71 1/2" 31 9/16"
80"	79 1/2" 32 5/8"	79 1/2" 32 5/8"	79 1/2" 32 5/8"	79 1/2" 32 5/8"	79 1/2" 32 5/8"
	OVSHSH5636	OVSHSH6436	OVSHSH7236	OVSHSHSH8436	OVSHSHSH9636
	OVSHSH5644	OVSHSH6444	OVSHSH7244	OVSHSHSH8444	OVSHSHSH9644
	OVSHSH5648	OVSHSH6448	OVSHSH7248	OVSHSHSH8448	OVSHSHSH9648
	OVSHSH5652	OVSHSH6452	OVSHSH7252	OVSHSHSH8452	OVSHSHSH9652
	OVSHSH5660	OVSHSH6460	OVSHSH7260	OVSHSHSH8460	OVSHSHSH9660
	OVSHSH5666	OVSHSH6466	OVSHSH7266	OVSHSHSH8466	OVSHSHSH9666
	OVSHSH5672	OVSHSH6472	OVSHSH7272	OVSHSHSH8472	OVSHSHSH9672
	—	—	—	OVSHSHSH8480	OVSHSHSH9680

Twin Single-Hung 2U1R2C[®] Horizontal Detail









Triple Single-Hung 3U1R3C[®] Horizontal Detail

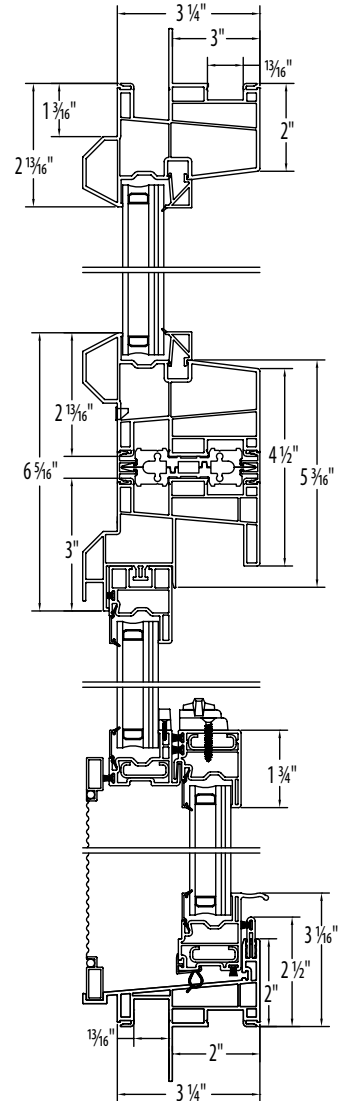

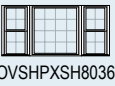
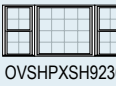
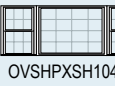
Rough Opening					Single-Hung with Transom 2U2R1C [®]		
					28"	32"	36"
Unit Size					27 1/2"	31 1/2"	35 1/2"
Sash Opening					21 7/16"	25 7/16"	29 7/16"
Visible Glass-Upper Sash					19 13/16"	23 13/16"	27 13/16"
Visible Glass-Sash					19 3/4"	23 3/4"	25 3/4"
60"	59 1/2"	19 9/16"	19 7/8"	5 3/4"			
					OVSHSTM2860	OVSHSTM3260	OVSHSTM3660
66"	65 1/2"	22 9/16"	22 7/8"	5 3/4"			
					OVSHSTM2866	OVSHSTM3266	OVSHSTM3666
72"	71 1/2"	25 9/16"	25 7/8"	5 3/4"			
					OVSHSTM2872	OVSHSTM3272	OVSHSTM3672
80"	79 1/2"	26 9/16"	26 7/8"	17 3/4"			
					OVSHSTM2880	OVSHSTM3280	OVSHSTM3680

Single-Hung with Transom 2U2R1C[®] Vertical Detail

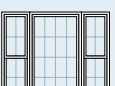

Rough Opening					Single-Hung/Picture/Single-Hung 3U1R3C [®]		
					80"	92"	104"
Unit Size					79 1/2"	23 1/2"	27 1/2"
SHPXSH Unit Configuration					20-40-20	24-44-24	28-48-28
Sash Opening					13 7/16"	17 7/16"	21 7/16"
Visible Glass-Sash					11 13/16"	15 13/16"	19 13/16"
Visible Glass-Fixed Center					33 3/4"	37 3/4"	41 3/4"
36"	35 1/2"	13 9/16"	13 7/8"	29 3/4"			
					OVSHPXSH8036	OVSHPXSH9236	OVSHPXSH10436
48"	47 1/2"	19 9/16"	19 7/8"	41 3/4"			
					OVSHPXSH8048	OVSHPXSH9248	OVSHPXSH10448
60"	59 1/2"	25 9/16"	25 7/8"	53 3/4"			
					OVSHPXSH8060	OVSHPXSH9260	OVSHPXSH10460

Single-Hung/Picture/Single-Hung 3U1R3C[®] Horizontal Detail

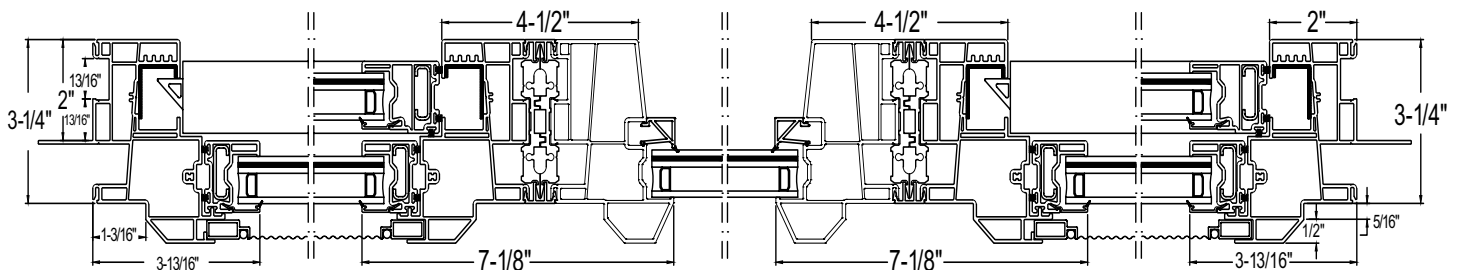

OceanView Double-Hung | Window Sizes and Detail Drawings





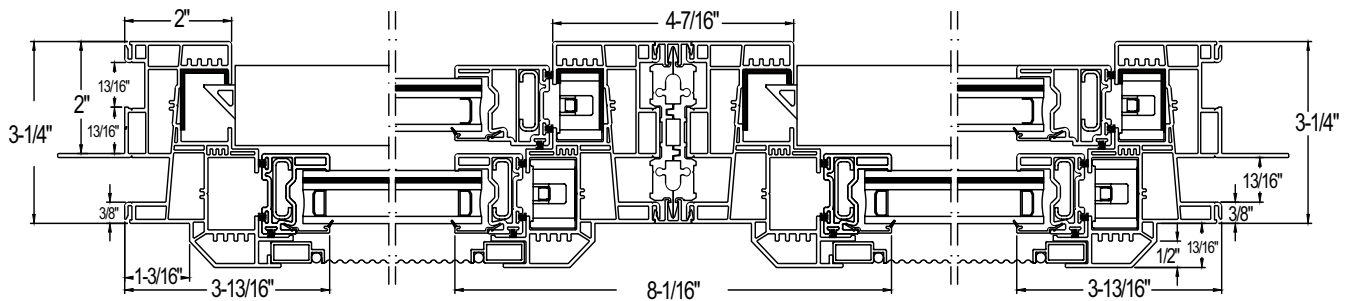



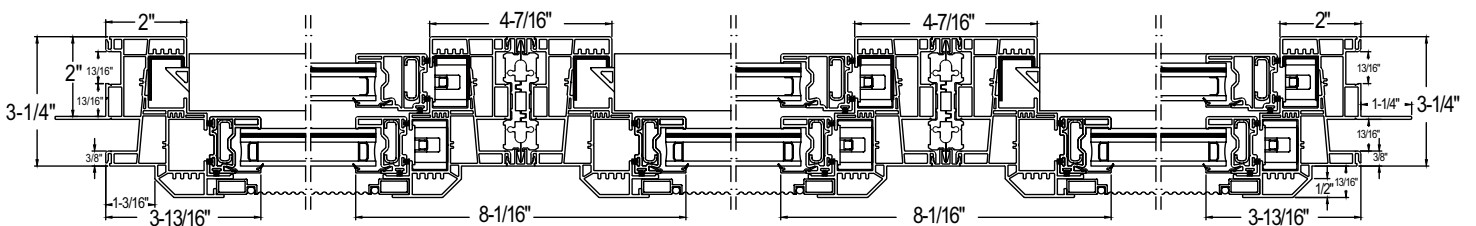

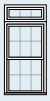
Rough Opening	Twin Double-Hung 2U1R2C [®]				Triple Double-Hung 3U1R3C [®]			
	56"	64"	72"	96"	84"	96"	108"	
Unit Size	55 1/2"	63 1/2"	71 1/2"	95 1/2"	83 1/2"	95 1/2"	107 1/2"	
Sash Opening	21 3/16"	25 3/16"	29 3/16"	41 3/16"	21 3/16"	25 3/16"	29 3/16"	
Visible Glass-Upper Sash	19 3/4"	23 3/4"	27 3/4"	39 3/4"	19 3/4"	23 3/4"	27 3/4"	
Visible Glass-Lower Sash	19 3/4"	23 3/4"	27 3/4"	39 3/4"	19 3/4"	23 3/4"	27 3/4"	
36"	35 1/2" 13 1/4" 13 1/8"	OVDHDH5636	OVDHDH6436	OVDHDH7236	OVDHDH9636	OVDHDHDH8436	OVDHDHDH9636	OVDHDHDH10836
44"	43 1/2" 17 1/4" 17 1/8"	OVDHDH5644	OVDHDH6444	OVDHDH7244	OVDHDH9644	OVDHDHDH8444	OVDHDHDH9644	OVDHDHDH10844
48"	47 1/2" 19 1/4" 19 1/8"	OVDHDH5648	OVDHDH6448	OVDHDH7248	OVDHDH9648	OVDHDHDH8448	OVDHDHDH9648	OVDHDHDH10848
52"	51 1/2" 21 1/4" 21 1/8"	OVDHDH5652	OVDHDH6452	OVDHDH7252	OVDHDH9652	OVDHDHDH8452	OVDHDHDH9652	OVDHDHDH10852
60"	59 1/2" 25 1/4" 25 1/8"	OVDHDH5660	OVDHDH6460	OVDHDH7260	OVDHDH9660	OVDHDHDH8460	OVDHDHDH9660	OVDHDHDH10860
62"	61 1/2" 26 1/4" 26 1/8"	OVDHDH5662	OVDHDH6462	OVDHDH7262	OVDHDH9662	OVDHDHDH8462	OVDHDHDH9662	OVDHDHDH10862
66"	65 1/2" 28 1/4" 28 1/8"	OVDHDH5666	OVDHDH6466	OVDHDH7266	OVDHDH9666	OVDHDHDH8466	OVDHDHDH9666	OVDHDHDH10866
72"	71 1/2" 31 1/4" 31 1/8"	OVDHDH5672	OVDHDH6472	OVDHDH7272	OVDHDH9672	OVDHDHDH8472	OVDHDHDH9672	OVDHDHDH10872
80"	79 1/2" 32 1/4" 35 1/8"	OVDHDH5680	OVDHDH6480	OVDHDH7280	OVDHDH9680	—	—	—

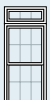
Twin Double-Hung 2U1R2C[®] Horizontal Detail









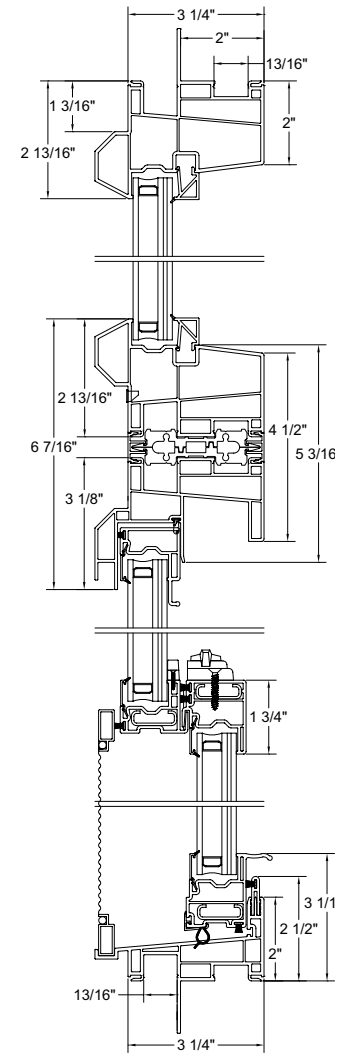





Triple Double-Hung 3U1R3C[®] Horizontal Detail



Rough Opening					Double-Hung with Transom 2U2R1C [®]		
					28"	32"	36"
Unit Size					27 1/2"	31 1/2"	35 1/2"
Sash Opening					21 7/16"	25 7/16"	29 7/16"
Visible Glass-Upper Sash					19 13/16"	23 13/16"	27 13/16"
Visible Glass-Sash					19 3/4"	23 3/4"	25 3/4"
60"	59 1/2"	19 9/16"	19 7/8"	5 3/4"			
						OVDHTSM2860	OVDHTSM3260
66"	65 1/2"	22 9/16"	22 7/8"	5 3/4"			
						OVDHTSM2866	OVDHTSM3266
72"	71 1/2"	25 9/16"	25 7/8"	5 3/4"			
						OVDHTSM2872	OVDHTSM3272
80"	79 1/2"	26 9/16"	26 7/8"	17 3/4"			
						OVDHTSM2880	OVDHTSM3280



Double-Hung with Transom 2U2R1C[®] Vertical Detail

Rough Opening					Double-Hung /Picture/Double-Hung 3U1R3C [®]			
					80"	92"	104"	124"
Unit Size					79 1/2"	91 1/2"	103 1/2"	123 1/2"
ODHPXDH Unit Configuration					20-40-20	24-44-24	28-48-28	32-60-32
Sash Opening					13 3/16"	17 3/16"	21 3/16"	25 3/16"
Visible Glass-Upper Sash					11 3/4"	15 3/4"	19 3/4"	23 3/4"
Visible Glass-Upper Center					33 3/4"	37 3/4"	41 3/4"	53 3/4"
Visible Glass-Fixed Lower					11 3/4"	15 3/4"	19 3/4"	23 3/4"
36"	35 1/2"	13 9/16"	13 7/8"	29 3/4"				
						OVDHPXDH8036	OVDHPXDH9236	OVDHPXDH10436
48"	47 1/2"	19 9/16"	19 7/8"	4 13/16"				
						OVDHPXDH8048	OVDHPXDH9248	OVDHPXDH10448
60"	59 1/2"	25 9/16"	25 7/8"	53 3/4"				
						OVDHPXDH8060	OVDHPXDH9260	OVDHPXDH10460

Double-Hung / Picture/Double-Hung 3U1R3C[®] Horizontal Detail

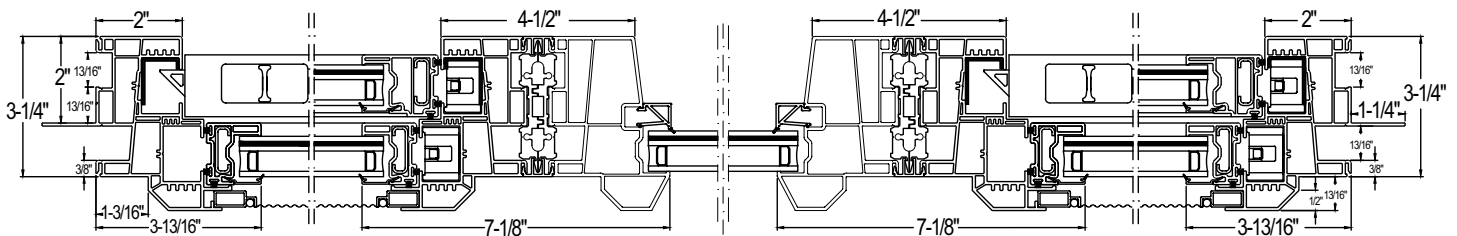

Callout sizes are expressed in inches and equal rough opening. Double-hung windows have an interior frame depth of 2"; exterior projection of the frame is 1-3/16" from the nail fin. When mulling a unit to a double-hung, overall rough opening is not affected by the mullion. 66" Tall windows are the maximum size available as oriels.

Oriels are windows having 60% to 40% sash height proportions with the larger sash on top. In reverse oriels, the smaller sash is on top.

- Meets egress of:
Clear opening area ≥ 5.7 sq. ft.
Clear opening width ≥ 20"
Clear opening height ≥ 24"

● 2U1R2C: Mullied two-unit (one row, two columns).

● 3U1R3C: Mullied three-unit (one row, three column).

● 2U2R1C: Mullied two-unit (two rows, one column).

■ All sizes shown meet DP50 rating.

For the latest testing data, contact Customer Service or visit our website at www.viwinco.com.

Extended Arch and Eyebrow									
Chord Height	4 3/8"	5 1/8"	5 7/8"	6 5/8"	7 7/16"	8 1/8"	9"	11 1/4"	13 1/2"
Radius	18"	21"	24"	27"	30"	32"	36"	45"	54"
Rough Opening	24"	28"	32"	36"	40"	44"	48"	60"	72"

Unit Size

Series

Shoulder Height (NET)

Series	Shoulder Height (NET)	Extended Arch and Eyebrow								
		4 3/8"	5 1/8"	5 7/8"	6 5/8"	7 7/16"	8 1/8"	9"	11 1/4"	13 1/2"
A	7 1/8"	Eyebrow								
A	7 1/8"									
B	19 1/8"	Extended Arch								
B	19 1/8"									
C	31 1/8"									
D	39 1/8"									
E	43 1/8"									
F	47 1/8"									
G	55 1/8"									
H	61 1/8"									
I	67 1/8"									

Grid patterns and styles

Series A: Extended arch

Colonial pattern.
Available in deluxe or flat grids between the glass.



Colonial

Starburst pattern.
Available in deluxe or flat grids between the glass.

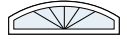

Starburst

Maximum number of spokes: 5
Minimum width for 5 spokes: 60"

Series B to L: Extended arch

Colonial pattern.
Available in deluxe or flat grids between the glass.

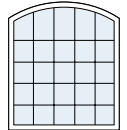

Colonial



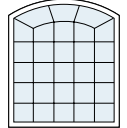











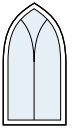
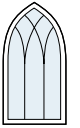
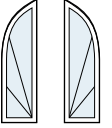
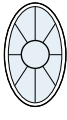

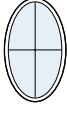
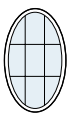

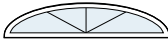











Cathedral pattern.
Available in deluxe or flat grids between the glass.

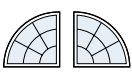
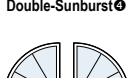

Cathedral

Rough Opening Width	24"	28"	32"	36"	40"	44"	48"	60"	72"
Series	Rough Opening Height								
A	12"	12 3/4"	13 1/2"	14 1/4"	15 1/8"	15 3/4"	16 1/2"	18 7/8"	13 1/8"
B	24"	24 3/4"	25 1/2"	26 1/4"	27 1/8"	27 3/4"	28 5/8"	30 7/8"	33 3/8"
C	36"	36 3/4"	37 1/2"	38 1/4"	39 1/8"	39 3/4"	40 5/8"	42 7/8"	45 1/8"
D	44"	44 3/4"	45 1/2"	46 1/4"	47 1/8"	47 3/4"	48 5/8"	50 7/8"	53 1/8"
E	48"	48 3/4"	49 1/2"	50 1/4"	51 1/8"	51 3/4"	52 5/8"	54 7/8"	57 1/8"
F	52"	52 3/4"	53 1/2"	54 1/4"	55 1/8"	55 3/4"	56 5/8"	58 7/8"	61 1/8"
G	60"	60 3/4"	61 1/2"	62 1/4"	63 1/8"	63 3/4"	64 5/8"	66 7/8"	-
H	66"	66 3/4"	67 1/2"	68 1/4"	69 1/8"	69 3/4"	70 5/8"	72 7/8"	-
I	72"	72 3/4"	73 1/2"	74 1/4"	75 1/8"	75 3/4"	76 5/8"	-	-

Rough opening height above equals shoulder height plus chord height plus 1/2".

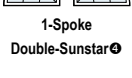
Circle	Gothic/ Half-Gothic	Oval/ Half-Oval	Elliptical	Octagon	Half-Round	Quarter-Round [®]
 <p>Sunburst</p>  <p>Starburst[Ⓢ]</p>  <p>Colonial Four-Lite</p>  <p>Colonial Nine-Lite</p> <p>Size Unit Dimensions OV-CIRCLE2424 23½" x 23½" OV-CIRCLE3030 29½" x 29½" OV-CIRCLE3636 35½" x 35½"</p>	 <p>One-Stem Tracery[Ⓢ]</p>  <p>Two-Stem Tracery[Ⓢ]</p> <p>Size Unit Dimensions OV-GOTH1836 17½" x 35½" OV-GOTH2040 19½" x 39½" OV-GOTH2244 21½" x 43½" OV-GOTH2448 23½" x 47½" OV-GOTH2856 27½" x 55½" OV-GOTH3060 29½" x 59½" OV-GOTH3672 35½" x 71½"</p> <p>Half-Gothic</p>  <p>Starburst[Ⓢ]</p> <p>Size (LEFT) Unit Dimensions OV-HGOTHL1854 17½" x 53½" OV-HGOTHL2260 21½" x 59½" OV-HGOTHL2666 25½" x 65½" OV-HGOTHL2872 27½" x 71½"</p> <p>Size (RIGHT) Unit Dimensions OV-HGOTHR1854 17½" x 53½" OV-HGOTHR2260 21½" x 59½" OV-HGOTHR2666 25½" x 65½" OV-HGOTHR2872 27½" x 71½"</p>	 <p>Sunburst</p>  <p>Starburst[Ⓢ]</p>  <p>Colonial Four-Lite</p>  <p>Colonial Nine-Lite</p> <p>Size Unit Dimensions OV-OVAL2436 23½" x 35½" OV-OVAL3656 35½" x 55½"</p> <p>Half-Oval</p>  <p>Sunburst</p>  <p>Starburst</p> <p>Size Unit Dimensions OV-HOVAL2418 23½" x 17½" OV-HOVAL3628 35½" x 27½"</p>	 <p>Starburst 3-Spoke</p>  <p>Sunstar 5-Spoke[Ⓢ]</p>  <p>Sunburst 5-Spoke[Ⓢ]</p> <p>Size Unit Dimensions OV-ELLIP6018 59½" x 17½" OV-ELLIP7220 71½" x 19½"</p> <p>For standard and custom orders, the maximum number of spokes is 5.</p>	 <p>Sunburst</p>  <p>Colonial Four-Lite</p>  <p>Colonial Nine-Lite</p> <p>Size Unit Dimensions OV-OCTA2424 23½" x 23½" OV-OCTA3232 31½" x 31½" OV-OCTA3636 35½" x 35½"</p>	 <p>Sunburst[Ⓢ]</p>  <p>Double-Sunburst[Ⓢ]</p>  <p>Triple-Sunburst[Ⓢ]</p>  <p>5-Spoke Sunburst[Ⓢ]</p>  <p>5-Spoke Double-Sunburst[Ⓢ]</p>  <p>5-Spoke Triple-Sunburst[Ⓢ]</p>  <p>Starburst</p>  <p>5-Spoke Starburst[Ⓢ]</p>  <p>Sunstar[Ⓢ]</p>  <p>Double-Sunstar[Ⓢ]</p>  <p>5-Spoke Triple-Sunstar[Ⓢ]</p> <p>Size Unit Dimensions OV-HRND2412 23½" x 11½" OV-HRND2814 27½" x 13½" OV-HRND3015 29½" x 14½" OV-HRND3216 31½" x 15½" OV-HRND3618 35½" x 17½" OV-HRND4020 39½" x 19½" OV-HRND4422 43½" x 21½" OV-HRND4824 47½" x 23½" OV-HRND5628 55½" x 27½" OV-HRND6030 59½" x 29½" OV-HRND6432 63½" x 31½" OV-HRND7236 71½" x 35½"</p> <p>For standard and custom orders, the maximum number of spokes is 5.</p>	 <p>2-Spoke Sunburst</p>  <p>2-Spoke Double-Sunburst[Ⓢ]</p>  <p>2-Spoke Starburst</p>  <p>1-Spoke Sunstar</p>  <p>2-Spoke Sunstar</p>  <p>1-Spoke Double-Sunstar[Ⓢ]</p>  <p>2-Spoke Double-Sunstar[Ⓢ]</p> <p>Size (LEFT) Unit Dimensions OV-QTRNDL2020 19½" x 19½" OV-QTRNDL2424 23½" x 23½" OV-QTRNDL2828 27½" x 27½" OV-QTRNDL3030 29½" x 29½" OV-QTRNDL3232 31½" x 31½" OV-QTRNDL3636 35½" x 35½"</p> <p>(left as viewed from outside)</p> <p>Size (RIGHT) Unit Dimensions OV-QTRNDR2020 19½" x 19½" OV-QTRNDR2424 23½" x 23½" OV-QTRNDR2828 27½" x 27½" OV-QTRNDR3030 29½" x 29½" OV-QTRNDR3232 31½" x 31½" OV-QTRNDR3636 35½" x 35½"</p> <p>(right as viewed from outside)</p>

Custom Shapes

Traditional rectangular, trapezoid, parallelogram, and other shapes utilizing fixed frames are available

Geometric Windows, Extended Arch and Eyebrow. Horizontal Detail

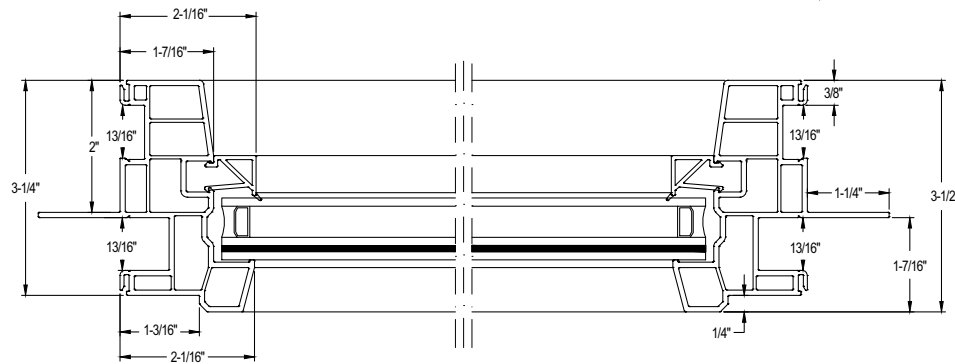

Fixed extended arch and eyebrow windows have an interior frame depth of 2" and an exterior projection from the nail fin of 1-3/4".

Callout sizes are expressed in inches (width) and equal rough opening.

Geometric windows have an interior frame depth of 2"; exterior projection of the frame is 1-3/16" from the nail fin.

Callout sizes are expressed in inches (width x height) and equal rough opening.

Unless otherwise noted, patterns are available in deluxe or flat grids between the glass.

Note: When geometric and picture windows are mull together, sightlines will not be even.

① Specify left-hand or right-hand as viewed from the exterior.

② Available with flat grids between the glass only.

③ Starburst, Sunburst, and Sunstar (5-spoke) patterns: minimum window size is 60" for either deluxe or flat grids.

④ Double-Sunburst and Double-Sunstar patterns: minimum window size is 48" for either deluxe or flat grids.

⑤ Sunstar and Sunburst (3-spoke) patterns: minimum window size is 28" for deluxe grids.

⑥ Triple-Sunstar and Triple-Sunburst patterns: minimum window size is 72" for either deluxe or flat grids.

■ All sizes shown meet DP50 rating.

For the latest testing data, contact Customer Service or visit our website at www.Viwinco.com.

Rough Opening	2-Lite Slider							
	24"	36"	48"	54"	60"	72"	84"	96"
Unit Size	23 1/2"	35 1/2"	47 1/2"	53 1/2"	59 1/2"	71 1/2"	83 1/2"	95 1/2"
Sash Opening	5 3/16"	11 3/16"	17 3/16"	20 3/16"	23 3/16"	29 3/16"	35 3/16"	41 3/16"
Visible Glass-Sash	7 1/8"	13 1/8"	19 1/8"	22 1/8"	25 1/8"	31 1/8"	37 1/8"	43 1/8"
24"	23 1/2" 17 3/16" 14 3/4"							
	OV2SL2424	OV2SL3624	OV2SL4824	OV2SL5424	OV2SL6024	OV2SL7224	OV2SL8424	OV2SL9624
36"	35 1/2" 29 3/16" 26 3/4"							
	OV2SL2436	OV2SL3636	OV2SL4836	OV2SL5436	OV2SL6036	OV2SL7236	OV2SL8436	OV2SL9636
42"	41 1/2" 35 3/16" 32 3/4"							
	OV2SL2442	OV2SL3642	OV2SL4842	OV2SL5442	OV2SL6042	OV2SL7242	OV2SL8442	OV2SL9642
48"	47 1/2" 41 3/16" 38 3/4"							
	OV2SL2448	OV2SL3648	OV2SL4848	OV2SL5448	OV2SL6048	OV2SL7248	OV2SL8448	OV2SL9648
60"	59 1/2" 53 3/16" 50 3/4"						—	—
	OV2SL2460	OV2SL3660	OV2SL4860	OV2SL5460	OV2SL6060	OV2SL7260		

2-Lite Slider Horizontal Detail

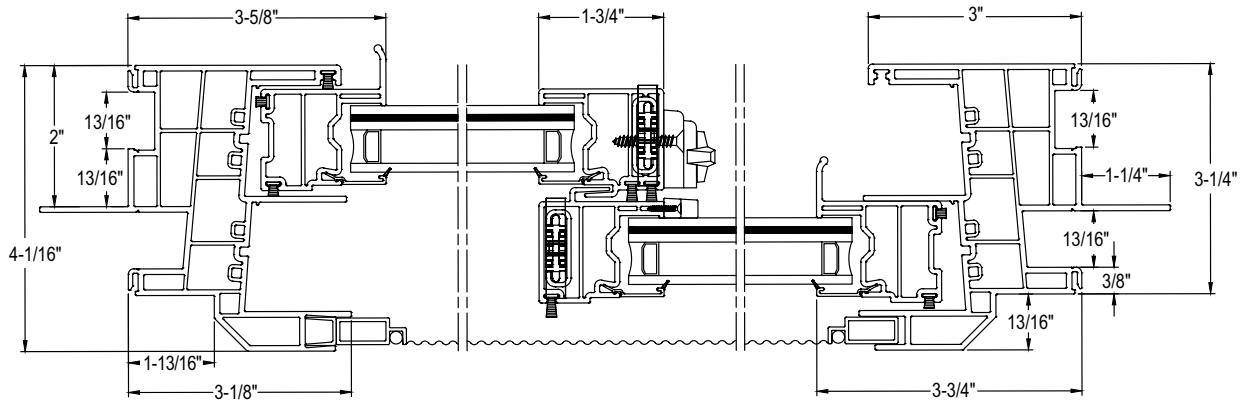

Rough Opening			Picture*										
			12"	20"	24"	28"	32"	36"	40"	44"	48"	60"	72"
Unit Size			11 1/2"	19 1/2"	23 1/2"	27 1/2"	31 1/2"	35 1/2"	39 1/2"	43 1/2"	47 1/2"	59 1/2"	71 1/2"
Visible Glass			5 3/4"	13 3/4"	17 3/4"	21 3/4"	25 3/4"	29 3/4"	33 3/4"	37 3/4"	41 3/4"	53 3/4"	65 3/4"
36"	35 1/2"	29 3/4"											
	OVPX1236	OVPX2036	OVPX2436	OVPX2836	OVPX3236	OVPX3636	OVPX4036	OVPX4436	OVPX4836	OVPX6036	OVPX7236		
42"	41 1/2"	35 3/4"											
	OVPX1242	OVPX2042	OVPX2442	OVPX2842	OVPX3242	OVPX3642	OVPX4042	OVPX4442	OVPX4842	OVPX6042	OVPX7242		
44"	43 1/2"	37 3/4"											
	OVPX1244	OVPX2044	OVPX2444	OVPX2844	OVPX3244	OVPX3644	OVPX4044	OVPX4444	OVPX4844	OVPX6044	OVPX7244		
48"	47 1/2"	41 3/4"											
	OVPX1248	OVPX2048	OVPX2448	OVPX2848	OVPX3248	OVPX3648	OVPX4048	OVPX4448	OVPX4848	OVPX6048	OVPX7248		
52"	51 1/2"	45 3/4"											
	OVPX1252	OVPX2052	OVPX2452	OVPX2852	OVPX3252	OVPX3652	OVPX4052	OVPX4452	OVPX4852	OVPX6052	OVPX7252		
60"	59 1/2"	53 3/4"											
	OVPX1260	OVPX2060	OVPX2460	OVPX2860	OVPX3260	OVPX3660	OVPX4060	OVPX4460	OVPX4860	OVPX6060	OVPX7260		
66"	65 1/2"	59 3/4"											
	OVPX1266	OVPX2066	OVPX2466	OVPX2866	OVPX3266	OVPX3666	OVPX4066	OVPX4466	OVPX4866	OVPX6066	OVPX7266		
72"	71 1/2"	65 3/4"											
	OVPX1272	OVPX2072	OVPX2472	OVPX2872	OVPX3272	OVPX3672	OVPX4072	OVPX4472	OVPX4872	OVPX6072	OVPX7272		

Picture & Transom Vertical Detail

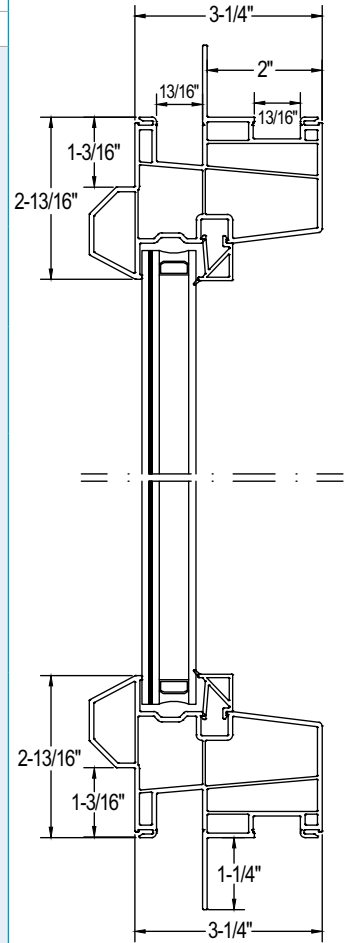

Rough Opening			Transom										
			28"	30"	32"	36"	40"	44"	48"	52"	56"	64"	72"
Unit Size			27 1/2"	29 1/2"	31 1/2"	35 1/2"	39 1/2"	43 1/2"	47 1/2"	51 1/2"	55 1/2"	63 1/2"	71 1/2"
Visible Glass			21 3/4"	23 3/4"	25 3/4"	29 3/4"	33 3/4"	37 3/4"	41 3/4"	45 3/4"	49 3/4"	57 3/4"	65 3/4"
12"	11 1/2"	5 3/4"											
	OVTSM2812	OVTSM3012	OVTSM3212	OVTSM3612	OVTSM4012	OVTSM4412	OVTSM4812	OVTSM5212	OVTSM5612	OVTSM6412	OVTSM7212		
18"	17 1/2"	11 3/4"											
	OVTSM2818	OVTSM3018	OVTSM3218	OVTSM3618	OVTSM4018	OVTSM4418	OVTSM4818	OVTSM5218	OVTSM5618	OVTSM6418	OVTSM7218		
24"	23 1/2"	17 3/4"											
	OVTSM2824	OVTSM3024	OVTSM3224	OVTSM3624	OVTSM4024	OVTSM4424	OVTSM4824	OVTSM5224	OVTSM5624	OVTSM6424	OVTSM7224		

Callout sizes are expressed in inches and equal rough opening.
 Slider, picture, and transom windows have an interior frame depth of 2"; exterior projection of the frame is 1-3/16" from the nail fin.
 When mulling a unit to a slider, picture, or transom overall rough opening is not affected by the mullion.
 Half-screen is standard for 2-lite slider
 *Picture windows up to 96" in length OR width are available (if width is increased, length is reduced, and vice versa)

- Meets egress of:
 Clear openable area ≥ 5.7 sq. ft.
 Clear openable width ≥ 20"
 Clear openable height ≥ 24"
- All sizes shown meet DP50 rating.

For the latest testing data, contact Customer Service or visit our website at www.viwinco.com.

Rough Opening	Casement						Twin Casement				
	18"	20"	24"	28"	30"	36"	36"	40"	48"	56"	72"
Unit Size	17 1/2"	19 1/2"	23 1/2"	27 1/2"	29 1/2"	35 1/2"	35 1/2"	39 1/2"	47 1/2"	55 1/2"	71 1/2"
Sash Opening	4 7/8"	6 7/8"	10 7/8"	14 7/8"	16 7/8"	22 7/8"	4 7/8"	6 7/8"	10 7/8"	14 7/8"	22 7/8"
Visible Glass-Sash	11 1/4"	13 1/4"	17 1/4"	21 1/4"	23 1/4"	29 1/4"	11 1/4"	13 1/4"	17 1/4"	21 1/4"	29 1/4"
24"	23 1/4" 17 1/4"	17 1/4"	17 1/4"	—	—	—	—	—	—	—	—
36"	35 1/2" 29 1/4"	29 1/4"	29 1/4"	—	—	—	—	—	—	—	—
42"	41 1/2" 35 1/4"	35 1/4"	35 1/4"	—	—	—	—	—	—	—	—
48"	47 1/2" 41 1/4"	41 1/4"	41 1/4"	—	—	—	—	—	—	—	—
52"	51 1/2" 45 1/4"	45 1/4"	45 1/4"	—	—	—	—	—	—	—	—
60"	59 1/2" 53 9/16"	53 9/16"	53 1/4"	—	—	—	—	—	—	—	—
66"	65 1/2" 58 1/4"	58 1/4"	58 1/4"	—	—	—	—	—	—	—	—
72"	71 1/2" 65 1/4"	65 1/4"	65 1/4"	—	—	—	—	—	—	—	—

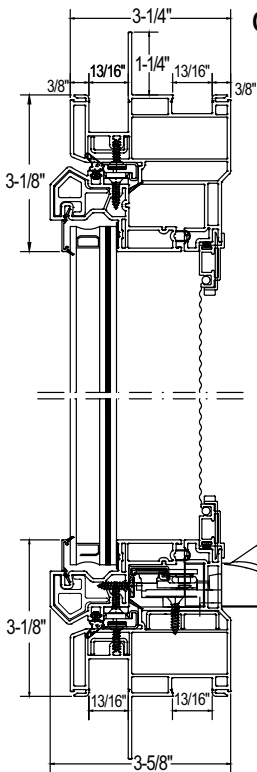

Casement Cross-Sectional Head & Sill Detail

Twin Casement Cross-Sectional Jamb Detail with Integral Mullion

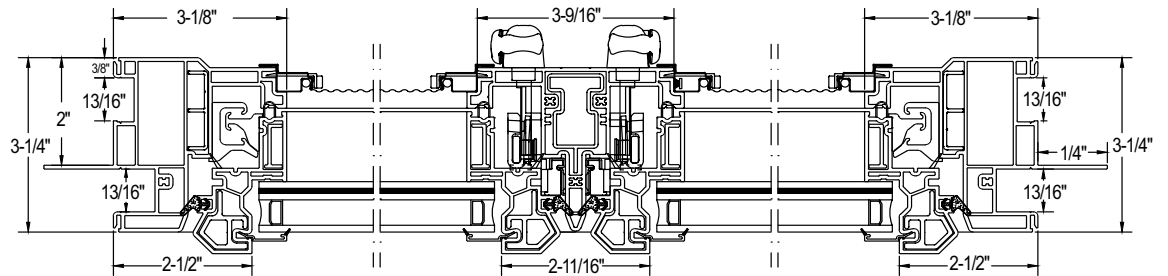

Rough Opening	Quad Casement				Casement/Picture/Casement				
	72"	80"	96"	112"	54"	60"	72"	84"	108"
Unit Size	71 1/2"	79 1/2"	95 1/2"	111 1/2"	53 1/2"	59 1/2"	71 1/2"	83 1/2"	107 1/2"
Sash Opening	4 7/8"	6 7/8"	10 7/8"	14 7/8"	4 7/8"	6 7/8"	10 7/8"	14 7/8"	22 7/8"
Visible Glass-Sash	11 1/4"	13 1/4"	17 1/4"	21 1/4"	11 1/4"	13 1/4"	17 1/4"	21 1/4"	29 1/4"
36"	35 1/2"	29 1/4"	29 1/4"						
	OVWW47236	OVWW48036	OVWW49636	OVWW411236	OVWW35436	OVWW36036	OVWW37236	OVWW38436	OVWW310836
42"	41 1/2"	35 1/4"	35 1/4"						
	OVWW47242	OVWW48042	OVWW49642	OVWW4112342	OVWW35442	OVWW36042	OVWW37242	OVWW38442	OVWW310842
48"	47 1/2"	41 1/4"	41 1/4"						
	OVWW47248	OVWW48048	OVWW49648	OVWW411248	OVWW35448	OVWW36048	OVWW37248	OVWW38448	OVWW310848
52"	51 1/2"	45 1/4"	45 1/4"						
	OVWW47252	OVWW48052	OVWW49652	OVWW411252	OVWW35452	OVWW36052	OVWW37252	OVWW38452	OVWW310852
60"	59 1/2"	53 9/16"	53 1/4"						
	OVWW47260	OVWW48060	OVWW49660	OVWW411260	OVWW35460	OVWW36060	OVWW37260	OVWW38460	OVWW310860
66"	65 1/2"	58 1/4"	58 1/4"						
	OVWW47266	OVWW48066	OVWW49666	OVWW411266	OVWW35466	OVWW36066	OVWW37266	OVWW38466	OVWW310866
72"	71 1/2"	65 1/4"	65 1/4"						
	OVWW47272	OVWW48072	OVWW49672	OVWW411272	OVWW35472	OVWW36072	OVWW37272	OVWW38472	OVWW310872

Quad Casement Horizontal Detail

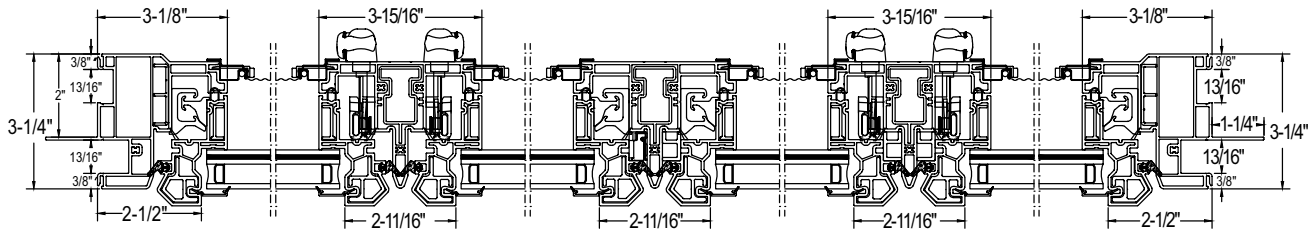

Casement/Picture/Casement Horizontal Detail

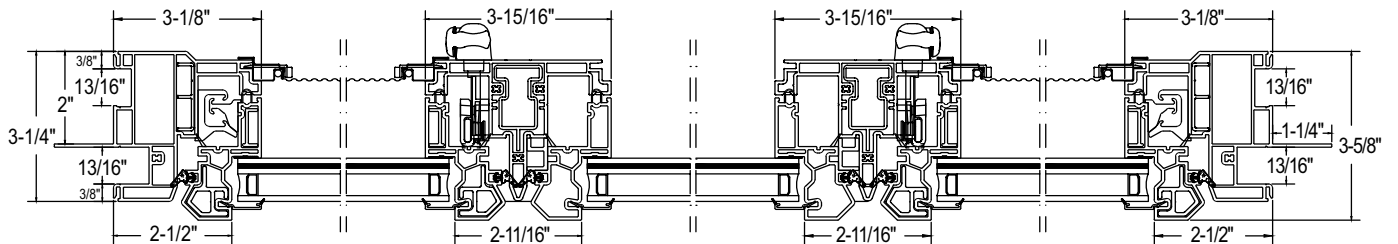

Callout sizes are expressed in inches and equal rough opening.
 Casement have an interior frame depth of 2" and an exterior projection of 1-5/8" from the nail fin.
 When mulling a unit to a casement, overall rough opening is not affected by the mullion.

- Meets egress of:
 Clear openable area ≥ 5.7 sq. ft.
 Clear openable width ≥ 20"
 Clear openable height ≥ 24"
- All sizes shown meet DP50 rating.

Colonial casement grid pattern option available for single casements and twin casement sizes.
 Colonial casements are designed to mimic the look of double-hung and single-hung windows but offer the larger opening of a casement. To order: Single casement - use the callout prefix OCCX. Twin casement - use the callout prefix OTCCX. Consult Customer Service for the exact grid pattern. Final grid layout to be approved by customer.

For the latest testing data, contact Customer Service or visit our website at www.Viwinco.com.

Rough Opening		Casement Picture (Fixed)				
		20"	24"	28"	30"	36"
Unit Size		19 1/2"	23 1/2"	27 1/2"	29 1/2"	35 1/2"
Visible Glass		13 1/4"	17 1/4"	21 1/4"	23 1/4"	29 1/4"
36"	35 1/2"					
	29 1/4"	OVCSMTPX2036	OVCSMTPX2436	OVCSMTPX2836	OVCSMTPX3036	OVCSMTPX3636
42"	41 1/2"					
	35 1/4"	OVCSMTPX2042	OVCSMTPX2442	OVCSMTPX2842	OVCSMTPX3042	OVCSMTPX3642
48"	47 1/2"					
	41 1/4"	OVCSMTPX2048	OVCSMTPX2448	OVCSMTPX2848	OVCSMTPX3048	OVCSMTPX3648
52"	51 1/2"					
	45 1/4"	OVCSMTPX2052	OVCSMTPX2452	OVCSMTPX2852	OVCSMTPX3052	OVCSMTPX3652
60"	59 1/2"					
	53 1/4"	OVCSMTPX2060	OVCSMTPX2460	OVCSMTPX2860	OVCSMTPX3060	OVCSMTPX3660
66"	65 1/2"					
	59 1/4"	OVCSMTPX2066	OVCSMTPX2466	OVCSMTPX2866	OVCSMTPX3066	OVCSMTPX3666
72"	71 1/2"					
	65 1/4"	OVCSMTPX2072	OVCSMTPX2472	OVCSMTPX2872	OVCSMTPX3072	OVCSMTPX3672

Rough Opening		Awning					
		24"	36"	40"	48"	56"	60"
Unit Size		23 1/2"	35 1/2"	39 1/2"	47 1/2"	55 1/2"	59 1/2"
Visible Glass		17 1/4"	29 1/4"	33 1/4"	41 1/4"	49 1/4"	53 1/4"
18"	17 1/2"						
	11 1/4"	OVAW2418	OVAW3618	OVAW4018	OVAW4818	OVAW5618	OVAW6018
20"	19 1/2"						
	13 1/4"	OVAW2420	OVAW3620	OVAW4020	OVAW4820	OVAW5620	OVAW6020
24"	23 1/2"						
	17 1/4"	OVAW2424	OVAW3624	OVAW4024	OVAW4824	OVAW5624	OVAW6024
28"	27 1/2"						
	21 1/4"	OVAW2428	OVAW3628	OVAW4028	OVAW4828	OVAW5628	OVAW6028
36"	35 1/2"						
	29 1/4"	OVAW2436	OVAW3636	OVAW4036	OVAW4836	OVAW5636	OVAW6036

Callout sizes are expressed in inches and equal rough opening.

Casement and awning windows have an interior frame depth of 2" and an exterior projection of 1-5/8" from the nail fin.

When mulling a unit to a casement or awning, overall rough opening is not affected by the mullion.

All sizes shown meet DP50 rating.

For the latest testing data, contact Customer Service or visit our website at www.viwinco.com.



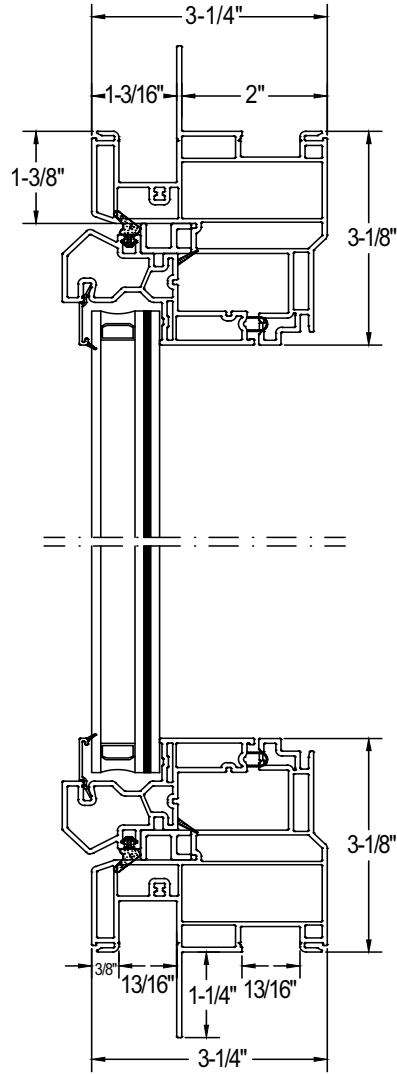

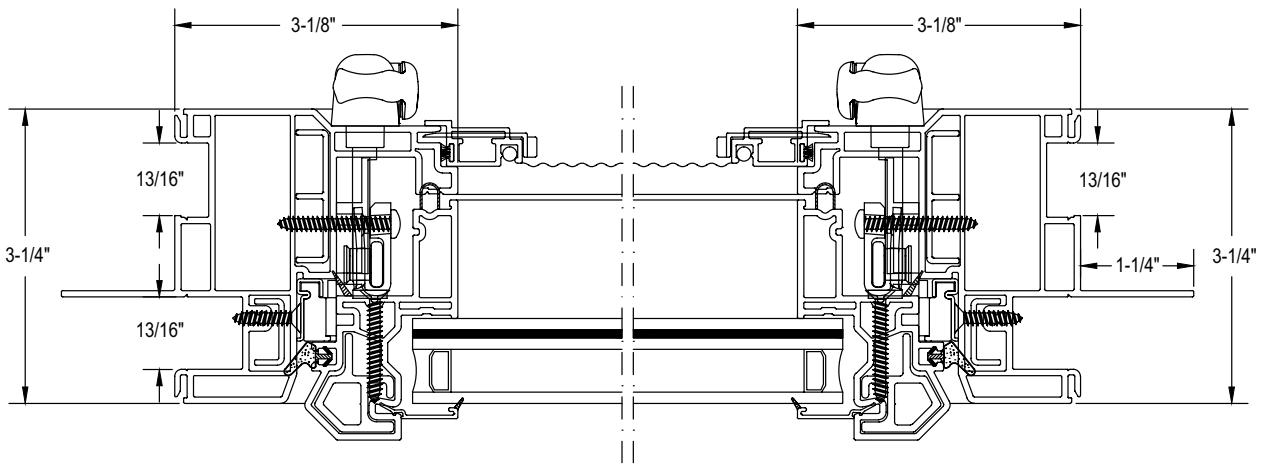

Casement Picture (Fixed)
Cross-Sectional Head & Sill Detail

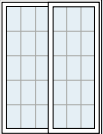
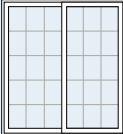
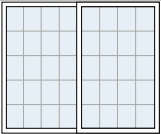
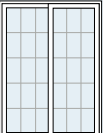
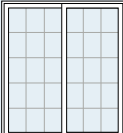
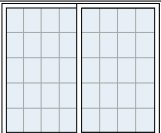
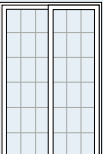
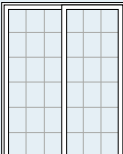
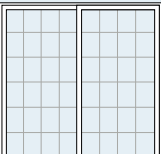

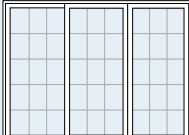
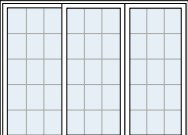
Awning Cross-Sectional Jamb Detail



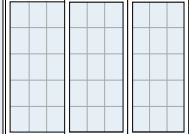

Rough Opening		Patio Door - 2-Panel (XO/OX)		
		60"	72"	96"
Unit Size		59 ½"	71 ½"	95 ½"
80"	79 ½"			
		OVPD26080	OVPD27280	OVPD29680
82"	81 ½"			
		OVPD26082	OVPD27282	OVPD29682
96"	95 ½"			
		OVPD26096	OVPD27296	OVPD29696
KD Assembly Available				

Rough Opening		Patio Door - 3-Panel - Vinyl Sill (OXO)		
		90"	108"	144"
Unit Size		89 ½"	107 ½"	143 ½"
80"	79 ½"			
		OVPD39080	OVPD310880	OVPD314480●
82"	81 ½"			
		OVPD39082	OVPD310882	OVPD314482●
96"	95 ½"			
		OVPD39096	OVPD310896●	OVPD314496●
KD Assembly Available				

Callout sizes are expressed in inches and equal rough opening.
 Patio doors have an interior frame depth of 3-3/8" and an exterior projection of 1-1/2" from the nail fin.
 Patio doors are not field reversible.
 Two-point lock with adjustable strikes on all patio doors.
 ● KD assembly only
 ■ All sizes shown meet DP50 rating.
 For the latest testing data, contact Customer Service or visit our website at www.Viwinco.com.

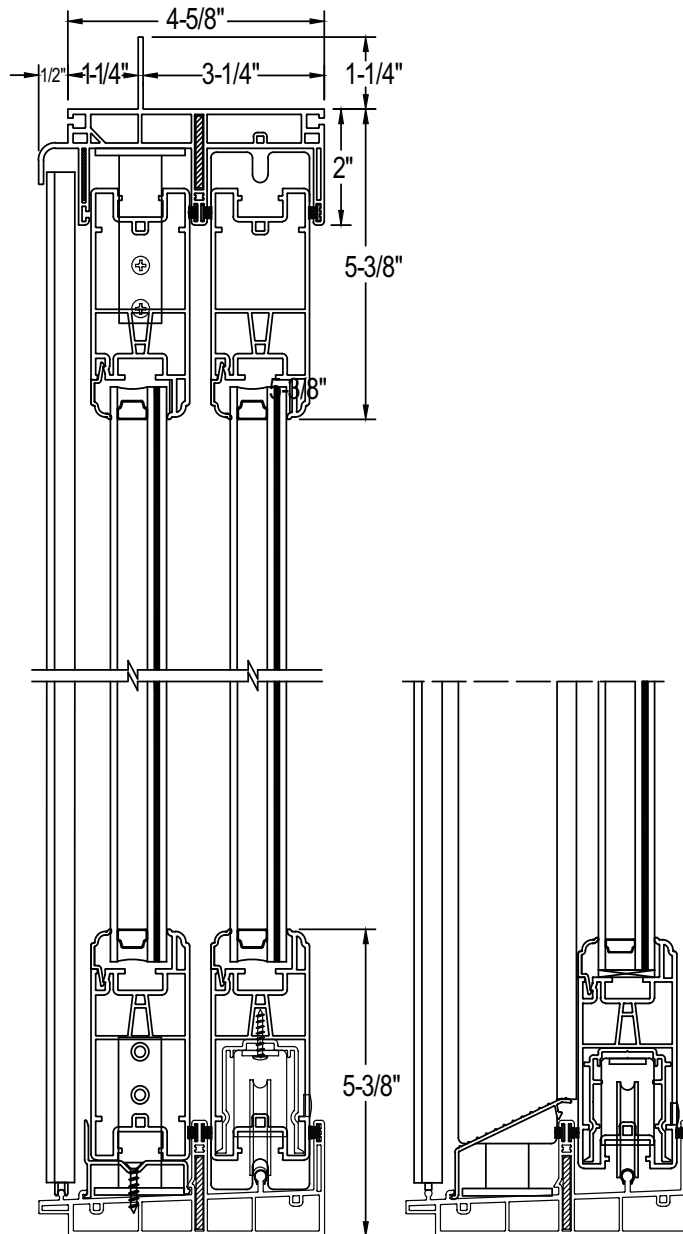
Patio Door – 2-Panel - Vinyl Sill
Sectional Head & Sill Detail

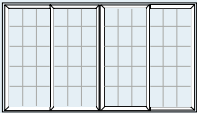
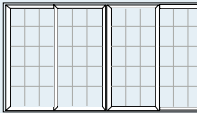
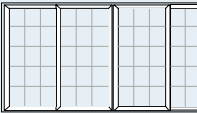
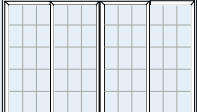
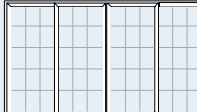

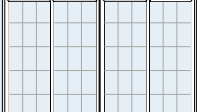
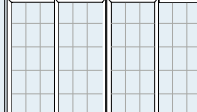
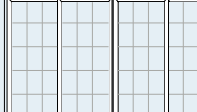
Rough Opening		Patio Door - 4-Panel - Vinyl Sill (OXXO)		
		118"	144"	192"
Unit Size		117 1/2"	143 1/2"	191 1/2"
80"	79 1/2"	 OVPD411880●	 OVPD414480●	 OVPD419280●
	82"	 OVPD411882●	 OVPD414482●	 OVPD419282●
96"	95 1/2"	 OVPD411896●	 OVPD414496●	 OVPD419296●

ONLY KD Assembly Available

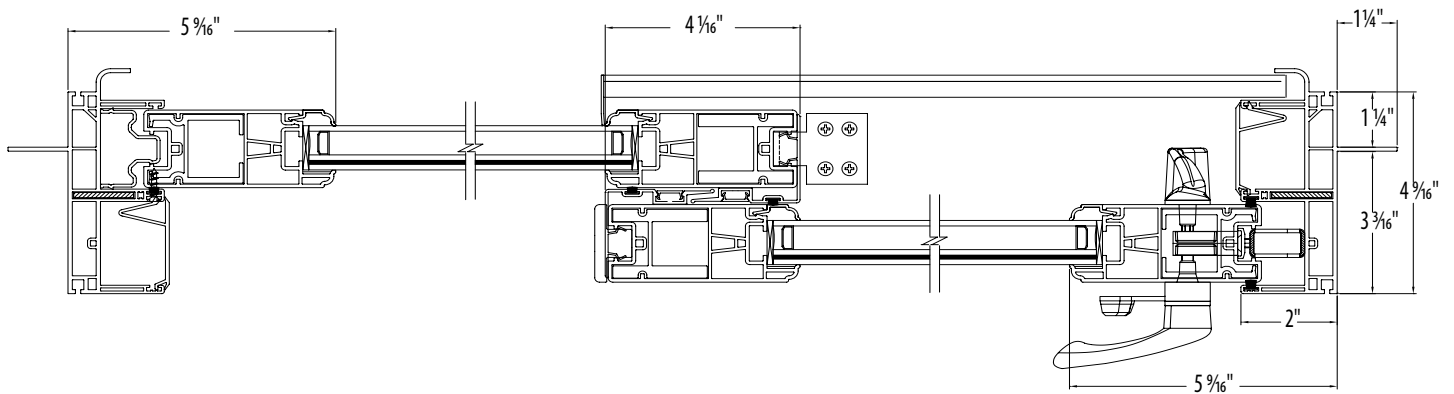

Patio Door Cross-Sectional Jamb Detail





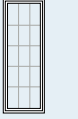
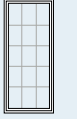
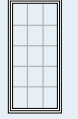
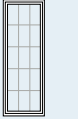
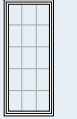
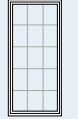

Callout sizes are expressed in inches and equal rough opening.
 Patio doors have an interior frame depth of 3-3/8" and an exterior projection of 1-1/2" from the nail fin.
 Patio doors are not field reversible.
 Two-point lock with adjustable strikes on all patio doors.

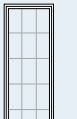
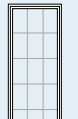
- KD assembly only
- All sizes shown meet DP50 rating.

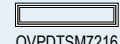
For the latest testing data, contact Customer Service or visit our website at www.Viwinco.com.



Rough Opening	Patio Door Sidelite			
	32"	38"	42"	48"
Unit Size	31 1/2"	37 1/2"	41 1/2"	47 1/2"
80"	79 1/2"			
		OVPDSL3280	OVPDSL3880	OPDSL4280
82"	81 1/2"			
		OVPDSL3282	OVPDSL3882	OPDSL4282
96"	95 1/2"			
		OVPDSL3296	OVPDSL3896	OPDSL4296

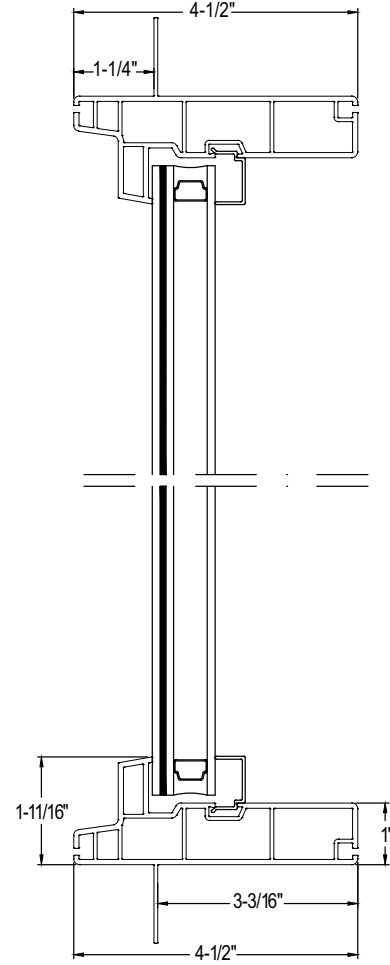

Rough Opening	Patio Door Transom		
	60"	72"	96"
Unit Size	59 1/2"	71 1/2"	95 1/2"
16"	15 1/2"		
		OVPDTSM6016	OVPDTSM7216
20"	19 1/2"		
		OVPDTSM6020	OVPDTSM7220
24"	23 1/2"		
		OVPDTSM6024	OVPDTSM7224

Sidelites and Transoms
Vertical Detail

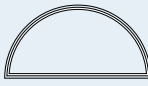

Callout sizes are expressed in inches and equal rough opening.
 Casement and awning windows have an interior frame depth of 2" and an exterior projection of 1-5/8" from the nail fin.
 When mulling a unit to a casement or awning, overall rough opening is not affected by the mullion.
All sizes shown meet DP50 rating.
 For the latest testing data, contact Customer Service or visit our website at www.Viwinco.com.

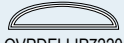
Rough Opening		Geometric shapes for patio doors — Half-Round		
		60"	72"	96"
Unit Size		59 1/2"	71 1/2"	95 1/2"
30"	29 1/2"	  		
36"	35 1/2"			
48"	47 1/2"			

Rough Opening		Geometric shapes for patio doors — Elliptical		
		60"	72"	96"
Unit Size		59 1/2"	71 1/2"	95 1/2"
18"	17 1/2"	  		
20"	19 1/2"			

Grid Patterns for Geometric Shapes — Half-Round

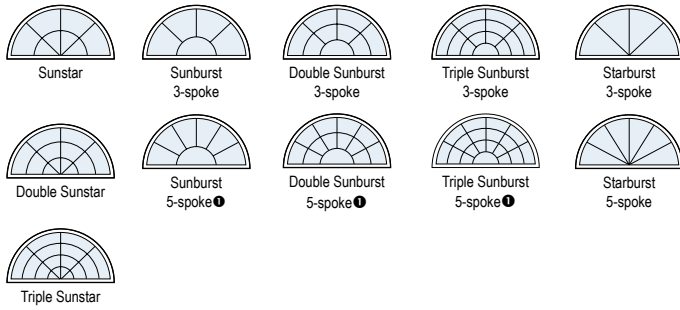

Grid Patterns for Geometric Shapes — Elliptical

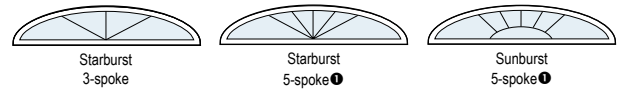

Callout sizes are expressed in inches and equal rough opening.
 Patio doors have an interior frame depth of 3-3/8" and an exterior projection of 1-1/2" from the nail fin.
 Transoms and sidelites have an interior frame depth of 3-3/8" and an exterior projection of 1-3/8" from the nail fin.
 When mulling a transom or sidelite to a patio door, add 1" to the overall rough opening total unit dimension for each mullion.

Patio doors are not field reversible. Two-point lock with adjustable strikes on all patio doors.

● 5-spoke starburst pattern: Minimum window size is 60" for either deluxe or flat grids.

NOTE: Direct-set glazing is set directly into the frame for more glass area in the opening.

■ All sizes shown meet DP50 rating.

For the latest testing data, contact Customer Service or visit our website at www.Viwinco.com.

3.5" Flat Casing Picture Frame w/ Pocket Filler Vertical Detail

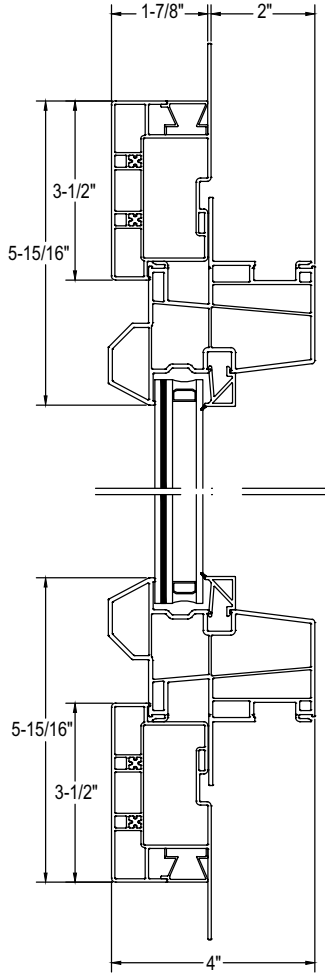

Brick Mold Casing w/ Bullnose Sill and Pocket Filler Vertical Detail

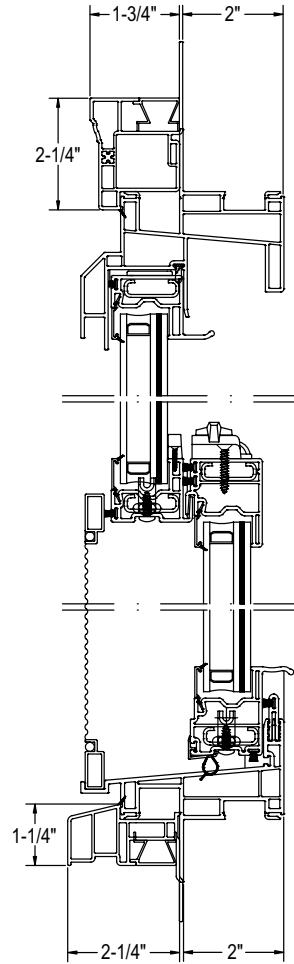

3.5" Flat Casing w/o Pocket Filler Horizontal Detail

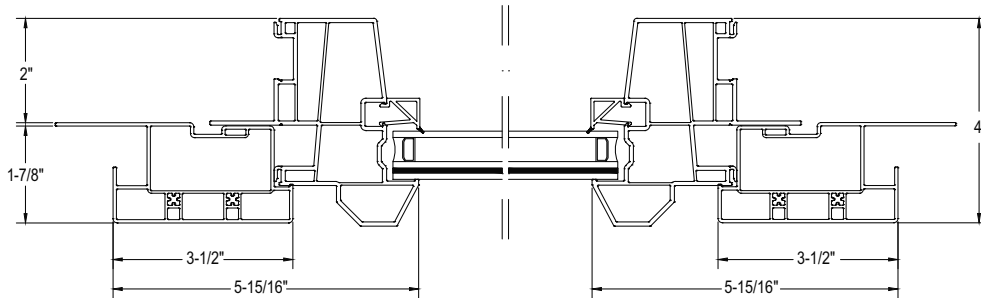

Brick Mold Casing w/o Pocket Filler Horizontal Detail

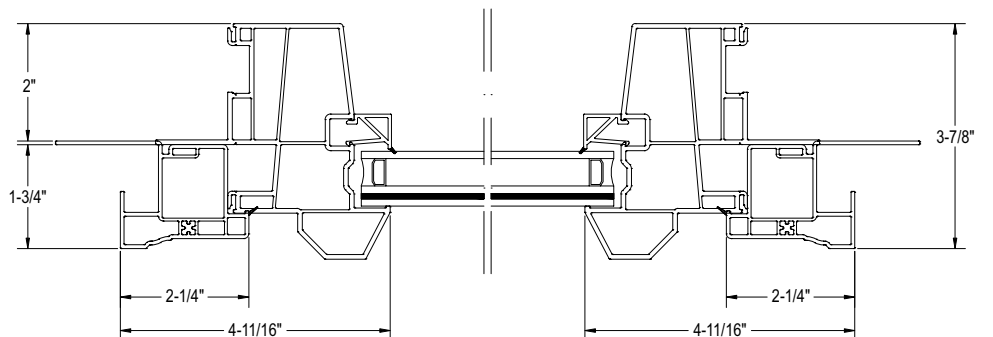

Products of the Future.

For over thirty years, Viwinco has embraced technical innovations and new manufacturing methods.

We're proud to now lead the marketplace with impact-resistant products that are manufactured in house from premium materials.

Our certification in safety glazing and our own certified test wall enable us to stay on the cutting edge of design, performance, and value. Plus, we individually craft every OceanView window to your exact specifications while maintaining one of the fastest turnaround times in the industry. Very territorial. And absolutely stunning. Impress the weather, no matter what it brings.



OV300 Updated © 2/2022 Viwinco Inc.



851 Hemlock Road · Morgantown, PA 19543
610-286-8884 | www.Viwinco.com

